

HENGE[®]

PRICE LIST
LISTINO PREZZI

2015

PRICE LIST
LISTINO PREZZI

2015

Cage-B	8
Cage-C	10
Frame Cabinet	11
SQ-Case	12
Q-Case	14
Tangram	17
Side-L	19
Side-H	20
Side-X	21
Slim Side	23
Hypnose Sofa	27
O-One Sofa	31
X-One Sofa	33
S-Day Bed	35
S-Perla Sofa	36
Octagon Table	40
Monolith Table	41
Network Table	42
Nomad Table	44
OR-Table	45
Pebble Table	46
R-Table	47
Poke Table	48
W-Table	49
Edge Mirror	51
H-Vases	52
Black Widow	53
Eighty Armchair	54
Is-A Chair	55
June Chair	56
Hexagon Chair	57
Rio Stool	58
Strip Chair	59
ES - Table	60
K-Table	61
LY-Table	64
Penny Table	67
Soprano	68
Stone Table	71
Light Ring	72
Pipe Light-L	77
Pipe Light-S	78
Tubular Light	79
U-Light	83
Y-Light	84
Light Disc	85
Flat Lamp	87

HENGE®

	Fabrics . Tessuti	Leather finishes . Finitura pelli			
		Shine Cat. 300	Nabuk Cat. 300	Durango Cat. 400	Nature Cat. 400
Hypnose Sofa	●	●	●		●
O-One Sofa	●	●	●		●
X-One Sofa	●	●	●		●
S-Perla Sofa	●	●	●	●	●
S-Day Bed	●	●	●	●	●
Eighty Armchair		●	●		●
Black Widow		●	●		●
Is-A Chair	●	●	●		●
June Chair	●	●	●	●	●
Hexagon Chair	●	●	●		●
Rio Stool				●	
Strip Chair			●	●	
Q-Case		●	●	●	●
Side-H		●	●		●
Side-L		●	●	●	●
K-Table		●		●	●
Soprano		●		●	
R-Table		●	●	●	●
W-Table		●	●	●	●

Cage-B

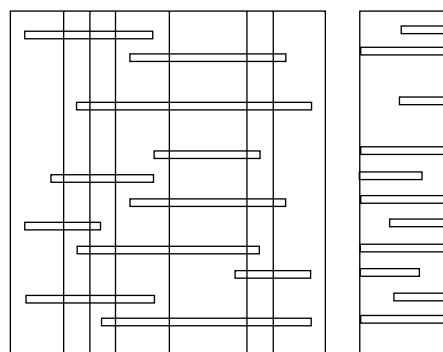

Bookshelf . Libreria 180x35x260

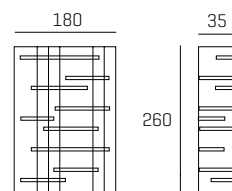

Wood species . Essenze

Oak Thermowood Rovere termizzato	CAGEB.CAGE01	8.161	8.978	10.659
Eucalyptus Thermowood Eucalipto termizzato				
Black Eucalyptus Thermowood Eucalipto nero termizzato				
Acacia Thermowood Acacia termizzato				
Swamp oak Rovere di palude		9.499	10.450	11.998

Surcharge for black burnished brass 3%
Maggiorazione per finitura ottone brunito nero 3%

Bookshelf . Libreria 180x45x260

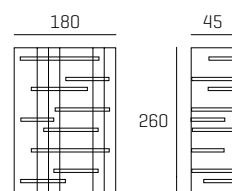

Wood species . Essenze

Oak Thermowood Rovere termizzato	CAGEB.CAGE02	9.470	10.194	12.028
Eucalyptus Thermowood Eucalipto termizzato				
Black Eucalyptus Thermowood Eucalipto nero termizzato				
Acacia Thermowood Acacia termizzato				
Swamp oak Rovere di palude		11.192	12.309	13.747

Surcharge for black burnished brass 3%
Maggiorazione per finitura ottone brunito nero 3%

Metal frame bookshelf

Structure

Square solid steel uprights, 1,5 x 1,5 cm, steel shelf supports.
Square brass pipe uprights, 1,5 x 1,5 cm, brass shelf supports.

Structure Finish

Black steel hand-burnished using traditional techniques.
Minium or dove grey paint finish. Brass hand-burnished using traditional techniques.

Shelves

5 cm thickness solidwood.

Shelves Finish

Heat treated woods as our samples and Swamp Oak
oil finish based on natural wax and water.

SIZES CAN BE CUSTOMIZED

Libreria in metallo con ripiani

Struttura

Montanti in acciaio quadro pieno 1,5 x 1,5 cm, supporti ripiani
in acciaio. Montanti in ottone quadro tubolare 1,5 x 1,5 cm,
supporti ripiani in ottone.

Finitura Struttura

Acciaio brunito nero a mano secondo le tecniche tradizionali.
Verniciato nei colori rosso minio o tortora. Ottone brunito
a mano secondo le tecniche tradizionali.

Ripiani

Legno listellare spessore 5 cm.

Finitura Ripiani

Legni termotrattati nelle finiture a campionario e rovere
di palude, finiti ad olio a base di cera naturale e acqua.

PERSONALIZZABILE A DISEGNO

Bookshelf . Libreria 240x35x260

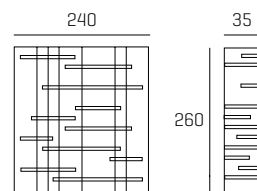

Wood species . Essenze

Oak Thermowood Rovere termizzato	CAGEB.CAGE03	10.365	11.401	13.267
Eucalyptus Thermowood Eucalipto termizzato				
Black Eucalyptus Thermowood Eucalipto nero termizzato				
Acacia Thermowood Acacia termizzato				
Swamp oak Rovere di palude		12.148	13.363	15.050

Surcharge for black burnished brass 3%
Maggiorazione per finitura ottone brunito nero 3%

Bookshelf . Libreria 240x45x260

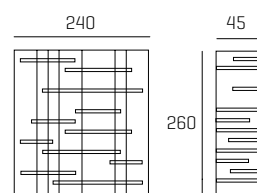

Wood species . Essenze

Oak Thermowood Rovere termizzato	CAGEB.CAGE04	12.690	13.958	15.698
Eucalyptus Thermowood Eucalipto termizzato				
Black Eucalyptus Thermowood Eucalipto nero termizzato				
Acacia Thermowood Acacia termizzato				
Swamp oak Rovere di palude		14.901	16.357	17.705

Surcharge for black burnished brass 3%
Maggiorazione per finitura ottone brunito nero 3%

Cage-B

Bookshelf . Libreria 260 x 35 x 115

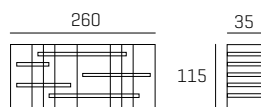

Wood species . Essenze

Oak Thermowood Rovere termizzato	CAGEB.CAGE07	7.726	8.498	10.335
Eucalyptus Thermowood Eucalipto termizzato				
Black Eucalyptus Thermowood Eucalipto nero termizzato				
Acacia Thermowood Acacia termizzato				
Swamp oak Rovere di palude				
		8.618	9.477	11.246

Surcharge for black burnished brass 3%
Maggiorazione per finitura ottone brunito nero 3%

Bookshelf . Libreria 260 x 45 x 115

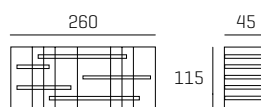

Wood species . Essenze

Oak Thermowood Rovere termizzato	CAGEB.CAGE08	8.598	9.457	11.268
Eucalyptus Thermowood Eucalipto termizzato				
Black Eucalyptus Thermowood Eucalipto nero termizzato				
Acacia Thermowood Acacia termizzato				
Swamp oak Rovere di palude				
		9.703	10.673	12.373

Surcharge for black burnished brass 3%
Maggiorazione per finitura ottone brunito nero 3%

Bookshelf . Libreria 260 x 35 x 133

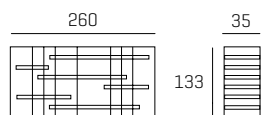

Wood species . Essenze

Oak Thermowood Rovere termizzato	CAGEB.CAGE05	8.307	9.137	10.963
Eucalyptus Thermowood Eucalipto termizzato				
Black Eucalyptus Thermowood Eucalipto nero termizzato				
Acacia Thermowood Acacia termizzato				
Swamp oak Rovere di palude				
		9.272	10.120	13.053

Surcharge for black burnished brass 3%
Maggiorazione per finitura ottone brunito nero 3%

Bookshelf . Libreria 260 x 45 x 133

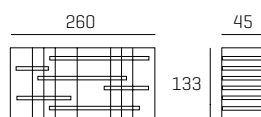

Wood species . Essenze

Oak Thermowood Rovere termizzato	CAGEB.CAGE06	9.470	10.415	11.921
Eucalyptus Thermowood Eucalipto termizzato				
Black Eucalyptus Thermowood Eucalipto nero termizzato				
Acacia Thermowood Acacia termizzato				
Swamp oak Rovere di palude				
		10.710	11.781	13.161

Surcharge for black burnished brass 3%
Maggiorazione per finitura ottone brunito nero 3%

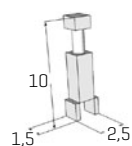

Ceiling support kit . Kit supporto a soffitto

180.00 € set of two . la coppia
Distance from ceiling 5 to 10 cm
Distanza da soffitto da 5 a 10 cm

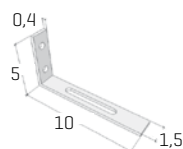

Wall support kit . Kit supporto a parete

Included in the price . Incluso nel prezzo
Distance from wall 0 to 5 cm
Distanza da parete da 0 a 5 cm

Cage-C

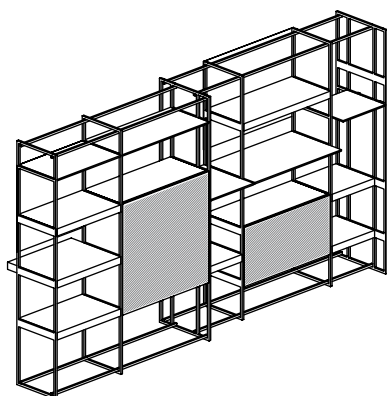

Cage-C - L.300 - P. 35/45 cm

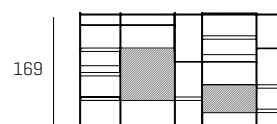

CAGEC.CAGE10

21.147

23.364

Cage-C - L.420 -P. 35/45 cm - TV panel . modulo TV

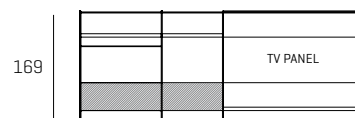

CAGEC.CAGE11

16.586

20.108

Cage-C - L.180 - P. 35/45 cm



CAGEC.CAGE12

13.958

14.426

Cage-C - L.510 - P. 35/45 cm

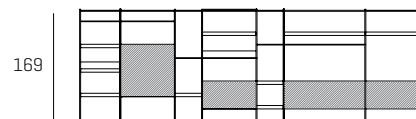

CAGEC.CAGE13

30.204

34.681

Cage-C - L.390 - P. 35/45 cm - TV panel . modulo TV

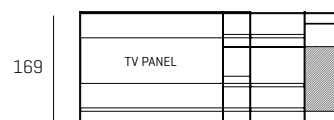

CAGEC.CAGE14

16.608

17.944

Cage-C - L.630 - P. 35/45 cm

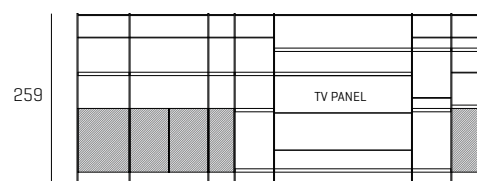

CAGEC.CAGE16

42.210

45.734

Back in cappuccino stone .
Schienale marmo cappuccino MTL

CAGEC.CAGE15

3.769

Double depth bookshelf

Structure

Square brass pipe structure, 1,5 x 1,5 cm - P. 35/45 cm

Finish

Finish hand-burnished using traditional techniques.

Shelves in 5 cm thick solidwood and 0,8 cm thick brass.

Storage units and back panels, sp. 2 cm

Finish

Finished in heat-treated Black Eucalyptus and Eucalyptus, heat-treated Oak and Swamp oak. Brass finish, hand-burnished using traditional techniques. Shelves and containers with plant oil finish based on natural wax and water. Shelves in 0,8 cm thick brass finish hand-burnished using traditional techniques.

35 cm and 45 cm depths available Heights can be chosen from composition examples shown or custom-made to customers' drawings.

SIZES CAN BE CUSTOMIZED

Libreria a doppia profondità, con mensole e contenitori

Struttura

Struttura in ottone tubolare quadro 1,5 x 1,5 cm - P. 35/45 cm

Finitura

Finitura brunita a mano secondo le tecniche tradizionali.

Ripiani in legno listellare spessore 5 cm e ottone sp. 0,8 cm

Contenitori e schienale porta TV, sp. 2 cm

Finitura

Finitura in Eucalipto e Eucalipto Nero termo trattato, Rovere termo trattato e Rovere di palude. Finitura ottone brunitura a mano secondo le tecniche tradizionali. Finitura mensole e contenitori olio vegetale a base di cera naturale e acqua. Ripiani sp. 0,8 cm in ottone brunito a mano secondo le tecniche tradizionali. Realizzata in profondità 35 cm e 45 cm altezze in composizioni suggerite oppure personalizzabile a disegno.

PERSONALIZZABILE A DISEGNO

Frame Cabinet

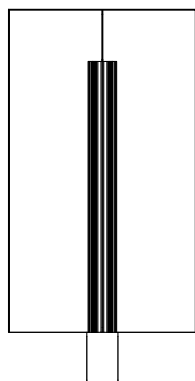

Structure

Structure and doors in 2 cm thick solidwood
 Frame of the handle in solid heat-treated oak, with closure
 in brass, hand-burnished using traditional techniques.
 Brass base, hand-burnished using traditional techniques.
Included: mandatory wall attachment kit.

Finish

Heat treated woods as our samples and Swamp Oak oil finish
 based on natural wax and water. Shelves in 1,2 cm Stopsol glass

Optional

1,2 cm thick solidwood trays
 Trays in brass, hand-burnished using traditional techniques.
 Back in laminated glass thick 0,3+0,3 cm with the inner linen fabric
 back-lighted.

DIMENSIONS

90 cm x 45 cm x 180 cm h

Struttura

Scocca e ante in legno listellare spessore 2 cm
 Cornice maniglia in massello di rovere termotrattato con chiusura
 in ottone brunito a mano secondo le tecniche tradizionali.
 Basamento in ottone brunito a mano secondo
 le tecniche tradizionali.

Di serie: kit per il fissaggio a muro obbligatorio.

Finitura

Legni termotrattati nelle finiture a campionario e rovere
 di palude, finiti ad olio a base di cera naturale e acqua.

Optional

Vassoi in legno listellare sp 1,2 cm
 Vassoi in ottone brunito a mano secondo le tecniche tradizionali.
 Schienale sp. 0,3+0,3 cm in vetro garzato retroilluminato.

DIMENSIONI

90 cm x 45 cm x 180 cm h

Frame Cabinet .
 versione standard 180 x 90H

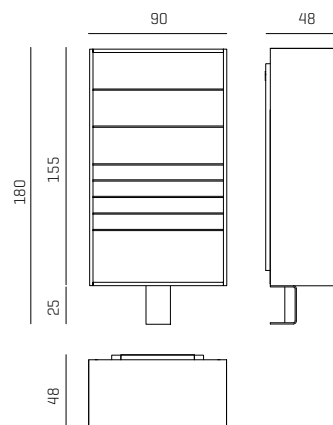

Frame Cabinet .
 versione bar 180 x 90H

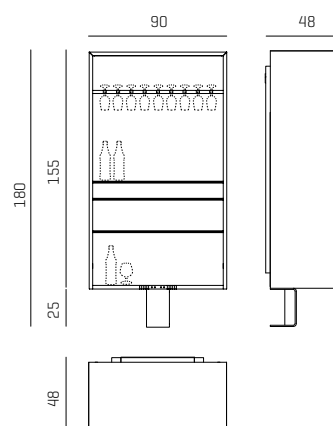

Wood species . Essenze

Oak Thermowood Rovere termizzato	FRAME.CAB01	7.979
Eucalyptus Thermowood Eucalpto termizzato		
Black Eucalyptus Thermowood Eucalpto nero termizzato		
Acacia Thermowood Acacia termizzato		
Swamp oak Rovere di palude		8.754

Wood species . Essenze

Oak Thermowood Rovere termizzato	FRAME.CAB01	8.024
Eucalyptus Thermowood Eucalpto termizzato		
Black Eucalyptus Thermowood Eucalpto nero termizzato		
Acacia Thermowood Acacia termizzato		
Swamp oak Rovere di palude		8.799

Optional

Backlit back Schienale interno in vetro retroilluminato	FRAME.ACC01	1.386
Internal trays in thermowood Vassoi interni in legno termizzato	FRAME.ACC02	183
Internal trays in burnished brass Vassoi interni in ottone brunito	FRAME.ACC03	250
Back External Led Light Luci Led esterne nella parte posteriore	FRAME.ACC06	700

SQ-CASE with glass doors and base SQ-CASE a terra con ante a vetro e zoccolo

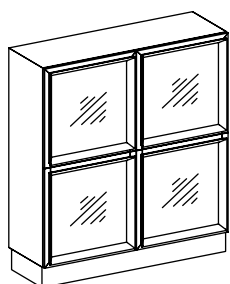

Structure

Solidwood, thickness 3,6 cm

Finish

Heat-treated Oak with plant oil finish based on natural wax and water. Shelf in 1,1 cm thick Stopsol glass.

Doors

5 cm thick solid heat-treated oak, concealed hinges for flush doors. 0,5 cm thick **Stopsol glass**, glazing bead in steel, hand-burnished using traditional techniques.

Included: mandatory wall attachment kit.

Base

Height 15 cm.

Finish

Steel, hand-burnished black using traditional techniques. Brass, hand-burnished using traditional techniques.

Optional

Trays in heat-treated oak with oil finish based on natural wax and water. Trays in brass, hand-burnished using traditional techniques. Back in 0,3+0,3 cm laminated glass with the inner linen fabric back-lighted.

DIMENSIONS

70 cm x 50 cm x 155 cm

140 cm x 50 cm x 155 cm

Scocca

Legno listellare spessore 3,6 cm.

Finitura

Rovere termotrattato. Finito ad olio a base di cera naturale e acqua.

Ripiani in Vetro Stopsol sp. 1,1 cm

Ante

Legno massello rovere termo trattato spessore 5 cm, Cerniere a scomparsa per ante a filo. Vetro Stopsol sp. 0,5 cm. Fermavetro in acciaio brunito a mano secondo le tecniche tradizionali.

Di serie: Kit per fissaggio a muro obbligatori.

Zoccolo

Altezza 15 cm.

Finitura

Acciaio brunito nero a mano secondo le tecniche tradizionali.

Ottone brunito a mano secondo le tecniche tradizionali.

Optional

Vassoi in rovere termo trattato finitura a olio a base di cera naturale e acqua. Vassoi in ottone brunito a mano secondo le tecniche tradizionali. Schienale retroilluminato in vetro accoppiato 0,3+0,3 cm con interno tessuto di lino.

DIMENSIONI

70 cm x 50 cm x 155 cm

140 cm x 50 cm x 155 cm

SQ-Case 70 x 155H

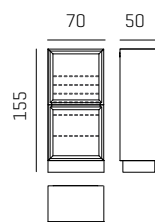

SQ-Case 140 x 155H

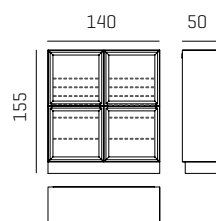

Burnished steel Acciaio brunito	CASE.Q026	4.058	5.424
Burnished Brass Ottone brunito		4.263	5.630

Burnished steel Acciaio brunito	CASE.Q023	6.679	8.064
Burnished Brass Ottone brunito		6.919	8.304

2 NATURAL LIGHTS LED KIT . KIT 2 LUCI LED NATURALI (MODULO DA 70): Euro 425
4 NATURAL LIGHTS LED KIT . KIT 4 LUCI LED NATURALI (MODULO DA 140): Euro 850

Optional

Internal trays unit in heat treated oak
Vassoi interni in rovere termotrattato

183 cad.

Internal trays unit in brass hand-burnished
Vassoi interni in ottone brunito

250 cad.

SQ-CASE with glass-top doors SQ-CASE in appoggio con ante a vetro

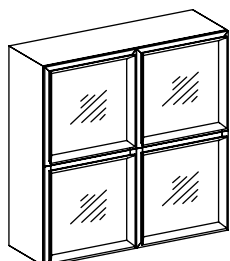

Structure

Solidwood, thickness 3,6 cm

Finish

Heat-treated oak with plant oil finish based on natural wax and water. Shelf in 1,1 cm thick Stopsol glass.

Doors

5 cm thick solid heat-treated oak, concealed hinges for flush doors. 0,5 cm thick **Stopsol glass**, glazing bead in steel, hand-burnished using traditional techniques.

Included: mandatory wall attachment kit.

Finish

Steel, hand-burnished black using traditional techniques. Brass, hand-burnished using traditional techniques.

Optional

Trays in heat-treated oak with plant oil finish based on natural wax and water. Trays in brass, hand-burnished using traditional techniques. Back in 0,3+0,3 cm laminated glass with the inner linen fabric back-lighted.

DIMENSIONS

70 cm x 50 cm x 70 cm
70 cm x 50 cm x 140 cm
140 cm x 50 cm x 70 cm
140 cm x 50 cm x 140 cm

Scocca

Legno listellare spessore 3,6 cm.

Finitura

Rovere termo trattato. Finito ad olio a base di cera naturale e acqua. Ripiani in Vetro stop sol sp. 1,1 cm

Ante

Legno massello rovere termo trattato spessore 5 cm, Cerniere a scomparsa per ante a filo Vetro Stopsol sp. 0,5 cm. Fermavetro in acciaio brunito a mano secondo le tecniche tradizionali.

Di serie: Kit per fissaggio a muro obbligatori.

Finitura

Acciaio brunito nero a mano secondo le tecniche tradizionali. Ottone brunito a mano secondo le tecniche tradizionali.

Optional

Vassoi in rovere termo trattato finitura a olio a base di cera naturale e acqua. Vassoi in ottone brunito a mano secondo le tecniche tradizionali. Schienale retroilluminato in vetro accoppiato 0,3+0,3 cm con interno tessuto di lino.

DIMENSIONI

70 cm x 50 cm x 70 cm
70 cm x 50 cm x 140 cm
140 cm x 50 cm x 70 cm
140 cm x 50 cm x 140 cm

Code . Codice

Oak Thermowood
Rovere termizzato

Backlit Glass
Vetro Retroilluminato

Finish of backrest . Finitura schienale

SQ-Case 70 x 70H

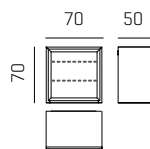

SQ-Case 140 x 70H

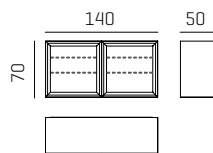

SQ-Case 70 x 140H

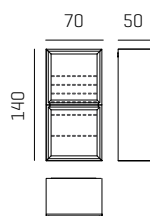

SQ-Case 140 x 140H

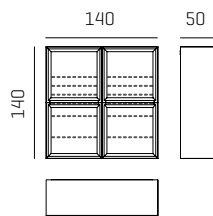

CASE.Q024	2.409	3.372
-----------	-------	-------

CASE.Q024	3.756	5.122
-----------	-------	-------

CASE.Q024	3.756	5.122
-----------	-------	-------

CASE.Q024	6.759	8.254
-----------	-------	-------

2 NATURAL LIGHTS LED KIT . KIT 2 LUCI LED NATURALI (MODULO DA 70): Euro 425
4 NATURAL LIGHTS LED KIT . KIT 4 LUCI LED NATURALI (MODULO DA 140): Euro 850

Optional

Internal trays unit in heat treated oak
Vassoi interni in rovere termo trattato 183 cad

Internal trays unit in brass hand-burnished
Vassoi interni in ottone brunito 250 cad.

Q-CASE with basement and glass doors Q-CASE a terra con ante a vetro

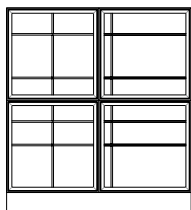

Structure

Solidwood, thickness 3,6 cm.

Finish

Heat treated oak. Oil finish based on natural wax and water.

Doors

Heat treated solid oak, thickness 5 cm. Glass backed, thickness 0,3 + 0,3 cm with interior with electro-coloured steel fabric.

Paint finish steel glazing bead. Concealed hinges for flush doors.

Included: mandatory wall attachment kit.

Base

Height 15 cm.

Finish

Black steel hand-burnished using traditional techniques.

Brass hand-burnished using traditional techniques.

Optional

Internal illumination with ledlight natural, energy saving with automatic ignition when the door is opened. Internal drawer units in solidwood.

DIMENSIONS

140 cm x 50 cm x 155 cm

70 cm x 50 cm x 155 cm

Scocca

Legno listellare spessore 3,6 cm.

Finitura

Rovere termo trattato. Finito ad olio a base di cera naturale e acqua.

Ante

Legno massello rovere termo trattato spessore 5 cm. Vetro accoppiato spessore 0,3 + 0,3 cm con interno tessuto d'acciaio elettrocolorato. Fermavetro in acciaio brunito. Cerniere a scomparsa per ante a filo.

Di serie: Kit per fissaggio a muro obbligatori.

Zoccolo

Altezza 15 cm.

Finitura

Acciaio brunito nero a mano secondo le tecniche tradizionali.

Ottone brunito a mano secondo le tecniche tradizionali.

Optional

Illuminazione interna con led luce naturale, basso consumo con accensione ad apertura ante. Cassettiere interne in legno di listellare.

DIMENSIONI

140 cm x 50 cm x 155 cm

70 cm x 50 cm x 155 cm

Finish of base Finitura basamento	Code . Codice	Oak Thermowood Rovere termizzato	Leather . Pelle cat. 300	Leather . Pelle cat. 400
Finish of backrest . Finitura schienale				

Q-Case 70 x 155H. Sx



Burnished steel Acciaio brunito	CASE.Q001	4.302	5.161	5.286
Burnished Brass Ottone brunito		4.519	5.378	5.504

Q-Case 70 x 155H. cen.



Burnished steel Acciaio brunito	CASE.Q002	4.302	5.161	5.286
Burnished Brass Ottone brunito		4.519	5.378	5.504

Q-Case 70 x 155H. Dx



Burnished steel Acciaio brunito	CASE.Q003	4.302	5.161	5.286
Burnished Brass Ottone brunito		4.519	5.378	5.504

Q-Case 140 x 155H. Sx

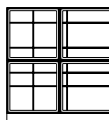

Burnished steel Acciaio brunito	CASE.Q004	7.646	9.023	9.243
Burnished Brass Ottone brunito		7.920	9.298	9.518

Q-Case 140 x 155H. Dx

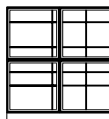

Burnished steel Acciaio brunito	CASE.Q005	7.646	9.023	9.243
Burnished Brass Ottone brunito		7.920	9.298	9.518

2 NATURAL LIGHTS LED KIT . KIT 2 LUCI LED NATURALI (MODULO DA 70): Euro 425

4 NATURAL LIGHTS LED KIT . KIT 4 LUCI LED NATURALI (MODULO DA 140): Euro 850

Code . Codice	Oak Thermowood Rovere termizzato
---------------	-------------------------------------

Internal equipment big Cassettiera interna grande

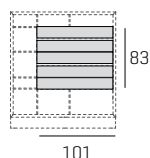

CASE.Q021

3.460

Internal equipment small Cassettiera interna piccola

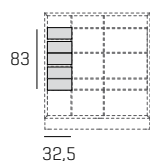

CASE.Q022

1.470

HENGE®

Q-CASE with glass doors Q-CASE in appoggio con ante a vetro

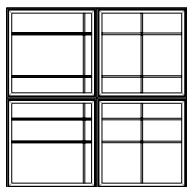

Structure

Solidwood, thickness 3,6 cm.

Finish

Heat treated oak. Oil finish based on natural wax and water.

Doors

Heat treated solid oak, thickness 5 cm. Glass backed, thickness 0,3 + 0,3 cm with interior with electro-coloured steel tweed fabric. Paint finish steel glazing bead. Concealed hinges for flush doors.

Included: mandatory wall attachment kit.

Optional

Internal illumination with cold light energy saving leds with autocolormatic ignition when the door is opened

DIMENSIONS

70 cm x 50 cm x 70 cm
70 cm x 50 cm x 140 cm
140 cm x 50 cm x 70 cm
140 cm x 50 cm x 140 cm

Scocca

Legno listellare spessore 3,6 cm.

Finitura

Rovere termo trattato. Finito ad olio a base di cera naturale e acqua.

Ante

Legno massello rovere termo trattato spessore 5 cm. Vetro accoppiato spessore 0,3 + 0,3 cm con interno tessuto d'acciaio elettrocolorato. Fermavetro in acciaio brunito. Cerniere a scomparsa per ante a filo.

Di serie: kit per il fissaggio a muro obbligatorio.











Optional

Illuminazione interna con led luce naturale, basso consumo con accensione ad apertura anta.

DIMENSIONI

70 cm x 50 cm x 70 cm
70 cm x 50 cm x 140 cm
140 cm x 50 cm x 70 cm
140 cm x 50 cm x 140 cm

2 NATURAL LIGHTS LED KIT . KIT 2 LUCI LED NATURALI (MODULO DA 70): Euro 425
4 NATURAL LIGHTS LED KIT . KIT 4 LUCI LED NATURALI (MODULO DA 140): Euro 850

Code . Codice	Oak Thermowood Rovere termizzato	Leather . Pelle cat. 300	Leather . Pelle cat. 400	
Finish of backrest . Finitura schienale				
Q-Case 70 x 70 Sx				
	CASE.Q006	2.365	2.777	2.826
Q-Case 70 x 70 Cen				
	CASE.Q007	2.365	2.777	2.826
Q-Case 70 x 70 Dx				
	CASE.Q008	2.365	2.777	2.826
Q-Case 140 x 70 Sx				
	CASE.Q009	3.981	4.840	4.967
Q-Case 140 x 70 Dx				
	CASE.Q010	3.981	4.840	4.967
Q-Case 70 x 140 Sx				
	CASE.Q011	3.981	4.840	4.967
Q-Case 70 x 140 Cen				
	CASE.Q012	3.981	4.840	4.967
Q-Case 70 x 140 Dx				
	CASE.Q013	3.981	4.840	4.967
Q-Case 140 x 140 Sx				
	CASE.Q014	7.166	8.543	8.763
Q-Case 140 x 140 Dx				
	CASE.Q015	7.166	8.543	8.763

Q-CASE with open shelves Q-CASE a terra a giorno

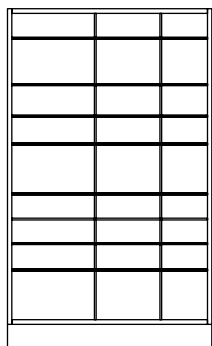

Finishes . Finitura	Code . Codice	Oak Thermowood Rovere termizzato	Leather . Pelle cat. 300	Leather . Pelle cat. 400
Finish of backrest . Finitura schienale				

Q-Case 140 x 225 Sx

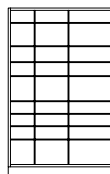

Burnished steel Acciaio brunito	CASE.Q019	6.483	8.086	8.337
Burnished Brass Ottone brunito		6.757	8.360	8.612

Q-Case 140 x 225 Dx

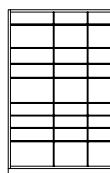

Burnished steel Acciaio brunito	CASE.Q020	6.483	8.086	8.337
Burnished Brass Ottone brunito		6.757	8.360	8.612

Structure

Solidwood, thickness 3,6 cm.

Finish

Heat treated oak. Oil finish based on natural wax and water.

Base

Height 15 cm.

Finish

Black steel hand-burnished using traditional techniques.

Brass hand-burnished using traditional techniques.

DIMENSIONS

140 cm x 50 cm x 225 cm

Scocca

Legno listellare spessore 3,6 cm.

Finitura

Rovere termo trattato. Finito ad olio a base di cera naturale e acqua.

Zoccolo

Altezza 15 cm.

Finitura

Acciaio brunito nero a mano secondo le tecniche tradizionali.

Ottone brunito a mano secondo le tecniche tradizionali.

DIMENSIONI

140 cm x 50 cm x 225 cm

Tangram

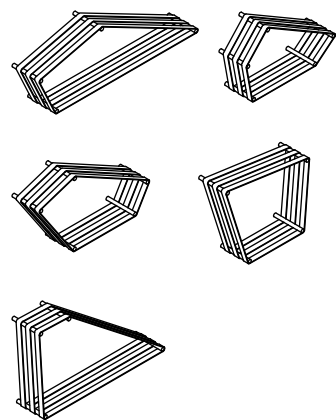

Structure

0,4 cm thick structure.

Finish

Structure in steel hand-burnished black using traditional techniques. Structure in brass, hand-burnished using traditional techniques

DIMENSIONS

72,5 cm x 24 cm x 64 cm h

131 cm x 24 cm x 43,2 cm h

77,5 cm x 24 cm x 49,5 cm h

105,4 cm x 24 cm x 65,4 cm h

96 cm x 24 cm x 56,5 cm h

Spacer to be used on compositions with Tangram bookshelves with 4 strips.

Struttura

Struttura sp. 0,4 cm

Finitura

Acciaio brunito nero e ottone brunito a mano secondo le tecniche tradizionali.

DIMENSIONI

72,5 cm x 24 cm x 64 cm h

131 cm x 24 cm x 43,2 cm h

77,5 cm x 24 cm x 49,5 cm h

105,4 cm x 24 cm x 65,4 cm h

96 cm x 24 cm x 56,5 cm h

Distanziale da utilizzare nelle composizioni con le Tangram a 4 fasce.

Tangram Bookshelves - A

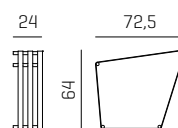

TAN.GRAMA3

1.431

1.936

Tangram Bookshelves - B

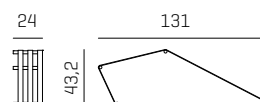

TAN.GRAMB3

1.431

1.936

Tangram Bookshelves - C

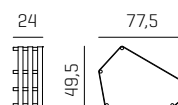

TAN.GRAMC3

1.463

1.994

Tangram Bookshelves - D

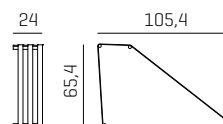

TAN.GRAMD3

1.431

1.936

Tangram Bookshelves - E

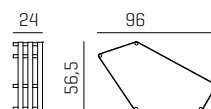

TAN.GRAME3

1.463

1.994

Tangram

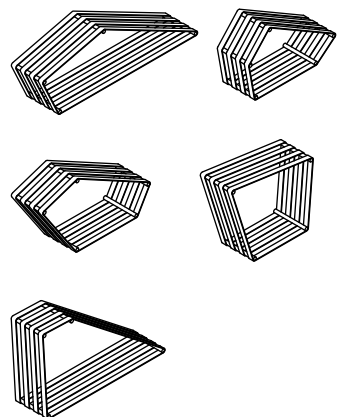

Tangram Bookshelves - A

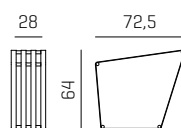

TAN.GRAMA4

1.890

2.563

Tangram Bookshelves - B

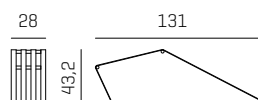

TAN.GRAMB4

1.890

2.563

Tangram Bookshelves - C

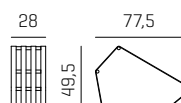

TAN.GRAMC4

1.933

2.641

Tangram Bookshelves - D



TAN.GRAMD4

1.890

2.563

Tangram Bookshelves - E



TAN.GRAME4

1.933

2.641

Structure

0,4 cm thick structure.

Finish

Structure in steel hand-burnished black using traditional techniques. Structure in brass, hand-burnished using traditional techniques

DIMENSIONS

72,5 cm x 28 cm x 64 cm h

131 cm x 28 cm x 43,2 cm h

77,5 cm x 28 cm x 49,5 cm h

105,4 cm x 28 cm x 65,4 cm h

96 cm x 28 cm x 56,5 cm h

Struttura

Struttura sp. 0,4 cm

Finitura

Acciaio brunito nero e ottone brunito a mano secondo le tecniche tradizionali

DIMENSIONI

72,5 cm x 28 cm x 64 cm h

131 cm x 28 cm x 43,2 cm h

77,5 cm x 28 cm x 49,5 cm h

105,4 cm x 28 cm x 65,4 cm h

96 cm x 28 cm x 56,5 cm h

Side-L

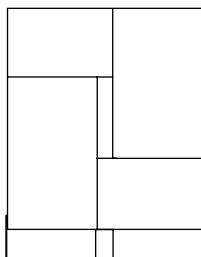

Side-L 115 x 49 x 150

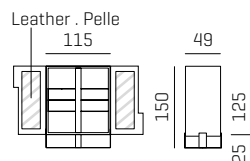

Structure

Solidwood, thickness 3,6 cm.

External finish and internal finish

Heat treated woods as our samples and Swamp Oak oil finish based on natural wax and water.

Doors

Solidwood, thickness 3,6 cm, flush.

Internal finish

Leather with finishes from the samples available. Burnished brass flat hinges for flush doors, base in burnished brass, cover for central partition in burnished brass. All brass burnishing carried out by hand with traditional methods.

Optional

Internal illumination with natural light energy saving leds with automatic ignition when the door is opened. Internal cross section in burnished brass.

DIMENSIONS

115 cm x 49 cm x 150 cm

Scocca

Legno listellare spessore 3,6 cm.

Finitura esterna ed interna

Legni termotrattati nelle finiture a campionario e rovere di palude finiti ad olio a base di cera naturale e acqua.

Ante

Legno listellare spessore 3,6 cm, filo cassa.

Finitura interna

Pelle nelle finiture a campionario. Cerniere piane per ante a filo in ottone brunito, basamento in ottone brunito.

Tutte le bruniture dell'ottone sono realizzate a mano secondo le tecniche tradizionali.

Optional

Illuminazione interna con led luce naturale, basso consumo con accensione ad apertura anta crociera interna in ottone brunito

DIMENSIONI

115 cm x 49 cm x 150 cm.

Standard model with height adjustable wooden shelves
Modello standard con ripiani in legno [regolabili in altezza]

Wood species . Essenze

Oak Thermowood Rovere termizzato	SIDE.LONG01	7.040	7.101
Eucalyptus Thermowood Eucalipto termizzato			
Black Eucalyptus Thermowood Eucalipto nero termizzato			
Acacia Thermowood Acacia termizzato			
Swamp oak Rovere di palude			
		8.739	8.792

Model with burnished brass cabinet [Mis. 48,7 cm x 39,2 cm x 25 cm]
Modello con contenitore in ottone brunito [Mis. 48,7 cm x 39,2 cm x 25 cm]

Wood species . Essenze

Oak Thermowood Rovere termizzato	SIDE.LONG02	9.020	9.080
Eucalyptus Thermowood Eucalipto termizzato			
Black Eucalyptus Thermowood Eucalipto nero termizzato			
Acacia Thermowood Acacia termizzato			
Swamp oak Rovere di palude			
		10.961	11.302

NATURAL LIGHTS LED KIT . KIT LUCI LED NATURALE: Euro 425

Side-H Wood . Legno

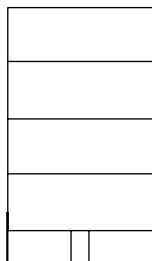

Structure

Solidwood, thickness 3,6 cm.

External and internal finish

Heat treated woods as our samples and Swamp Oak oil finish based on natural wax and water.

Doors

Solidwood, thickness 3,6 cm, flush.

Internal finish

Leather with finishes from the samples available.

Burnished brass flat hinges for flush doors, base in burnished brass.

All brass burnishing carried out by hand with traditional methods.

Optional

Internal illumination with natural light energy saving leds with automatic ignition when the door is opened.

DIMENSIONS

77,5 cm x 49 cm x 145 cm

Scocca

Legno listellare spessore 3,6 cm.

Finitura esterna ed interna

Legni termotrattati nelle finiture a campionario e rovere di palude, finiti ad olio a base di cera naturale e acqua.

Ante

Legno Listellare spessore 3,6 cm, filo cassa.

Finitura interna

Pelle nelle finiture a campionario. Cerniere piane per ante a filo in ottone brunito, basamento in ottone brunito.

Tutte le bruniture dell'ottone sono realizzate a mano secondo le tecniche tradizionali.

Optional

Illuminazione interna con led luce naturale, basso consumo con accensione ad apertura anta.

DIMENSIONI

77,5 cm x 49 cm x 145 cm

Finishes . Finitura

Code . Codice

Leather . Pelle
cat. 300

Leather . Pelle
cat. 400

Side-H 77,5 x 49 x 145

Leather . Pelle

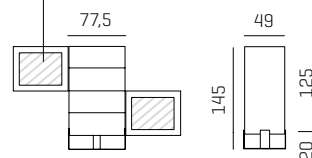

Standard model with wooden shelves
Modello standard con ripiani in legno

Wood species . Essenze

Oak Thermowood Rovere termizzato	SIDE.HIGHT03	5.002	5.045
Eucalyptus Thermowood Eucalipto termizzato			
Black Eucalyptus Thermowood Eucalipto nero termizzato			
Acacia Thermowood Acacia termizzato			
Swamp oak Rovere di palude		5.778	5.813

Side-H 77,5 x 49 x 145

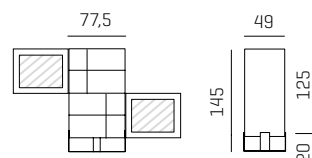

Model with wooden partitions
Modello con divisori in legno

Wood species . Essenze

Oak Thermowood Rovere termizzato	SIDE.HIGHT04	5.283	5.326
Eucalyptus Thermowood Eucalipto termizzato			
Black Eucalyptus Thermowood Eucalipto nero termizzato			
Acacia Thermowood Acacia termizzato			
Swamp oak Rovere di palude		6.116	6.124

NATURAL LIGHTS LED KIT . KIT LUCI LED NATURALE: Euro 425

Side-X

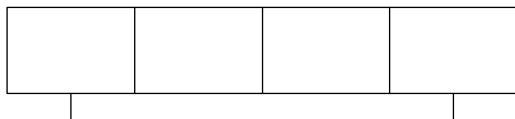

240 x 57 x 65

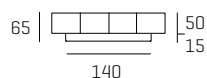

Structure

In solidwood, sides thickness 3,6 cm, bottom thickness 5 cm.

Doors

In solidwood, thickness 2,2 cm, flush.

Top

In solidwood, thickness 5 cm.

Finish

Heat treated woods as our samples and Swamp Oak oil finish based on natural wax and water.

Top in stone, thickness 2 cm

Cappuccino stone sand-sprayed and brushed.

Top in metal mesh finish

Burnished steel mesh tweed pattern.

Base

Black steel hand-burnished using traditional techniques.
Brass hand-burnished using traditional techniques.

Optional

Internal partitions in lacquered petrol blue solidwood.

DIMENSIONS

240 cm x 57 cm x 65 cm

280 cm x 57 cm x 65 cm

Scocca

Legno listellare fianchi spessore 3,6 cm, fondo spessore 5 cm.

Finitura

Legni termotrattati nelle finiture a campionario e rovere di palude, finiti ad olio a base di cera naturale e acqua.

Ante

Legno listellare spessore 2,2 cm, filo cassa.

Finitura

Legni termotrattati nelle finiture a campionario e rovere di palude finiti ad olio a base di cera naturale e acqua. Cerniere a scomparsa per ante a filo.

Top

In legno listellare spessore 5 cm.

Finitura Pietra spessore 2 cm

Cappuccino idrosabbaiato spazzolato.

Finitura in maglia metallica

Maglia d'acciaio tweed brunito.

Zoccolo

Acciaio brunito nero a mano secondo le tecniche tradizionali.

Ottone brunito a mano secondo le tecniche tradizionali.

DIMENSIONI

240 cm x 57 cm x 65 cm

280 cm x 57 cm x 65 cm

Finish of frame Finitura struttura	Code Codice	Thermowood Legno termotrattato	Swamp oak. Rovere di palude	Metal mesh Rete metallica	Cappuccino
Top finishes . Finitura top					

Base in burnished black steel . Basamento in acciaio brunito

Oak Thermowood Rovere termizzato	SIDE X001	7.367	-	8.528	9.771
Eucalyptus Thermowood Eucalipto termizzato					
Black Eucalyptus Thermowood Eucalipto nero termizzato					
Acacia Thermowood Acacia termizzato					
Swamp oak Rovere di palude		-	9.056	10.217	11.459

Base in burnished brass . Basamento in ottone brunito

Oak Thermowood Rovere termizzato	SIDE X001	7.872	-	9.033	10.047
Eucalyptus Thermowood Eucalipto termizzato					
Black Eucalyptus Thermowood Eucalipto nero termizzato					
Acacia Thermowood Acacia termizzato					
Swamp oak Rovere di palude		-	9.559	10.720	11.936

Side-X

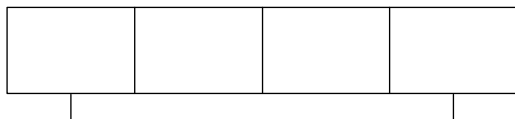

280 x 57 x 65

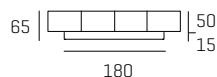

Finish of frame Finitura struttura	Code Codice	Thermowood Legno termotrattato	Swamp oak . Rovere di palude	Metal mesh Rete metallica	Cappuccino
Top finishes . Finitura top					

Base in burnished black steel . Basamento in acciaio brunito

Oak Thermowood Rovere termizzato	SIDE X002	8.412	-	10.154	10.901
Eucalyptus Thermowood Eucalipto termizzato					
Black Eucalyptus Thermowood Eucalipto nero termizzato					
Acacia Thermowood Acacia termizzato					
Swamp oak Rovere di palude					

Base in burnished brass . Basamento in ottone brunito

Oak Thermowood Rovere termizzato	SIDE X002	8.936	-	10.681	11.542
Eucalyptus Thermowood Eucalipto termizzato					
Black Eucalyptus Thermowood Eucalipto nero termizzato					
Acacia Thermowood Acacia termizzato					
Swamp oak Rovere di palude					

Structure

In solidwood, sides thickness 3,6 cm, bottom thickness 5 cm.

Doors

In solidwood, thickness 2,2 cm, flush.

Top

In solidwood, thickness 5 cm.

Finish

Heat treated woods as our samples and Swamp Oak oil finish based on natural wax and water.

Top in stone, thickness 2 cm

Cappuccino stone sand-sprayed and brushed.

Top in metal mesh finish

Burnished steel mesh tweed pattern.

Base

Black steel hand-burnished using traditional techniques.
Brass hand-burnished using traditional techniques.

Optional

Internal partitions in lacquered petrol blue solidwood.

DIMENSIONS

240 cm x 57 cm x 65 cm

280 cm x 57 cm x 65 cm

Scocca

Legno listellare fianchi spessore 3,6 cm, fondo spessore 5 cm.

Finitura

Legni termotrattati nelle finiture a campionario e rovere di palude, finiti ad olio a base di cera naturale e acqua.

Ante

Legno listellare spessore 2,2 cm, filo cassa.

Finitura

Legni termotrattati nelle finiture a campionario e rovere di palude finiti ad olio a base di cera naturale e acqua. Cerniere a scomparsa per ante a filo.

Top

In legno listellare spessore 5 cm.

Finitura Pietra spessore 2 cm

Cappuccino idrosabbato spazzolato.

Finitura in maglia metallica

Maglia d'acciaio tweed brunito.

Zoccolo

Acciaio brunito nero a mano secondo le tecniche tradizionali.

Ottone brunito a mano secondo le tecniche tradizionali.

DIMENSIONI

240 cm x 57 cm x 65 cm

280 cm x 57 cm x 65 cm

Slim Side Wood Legno

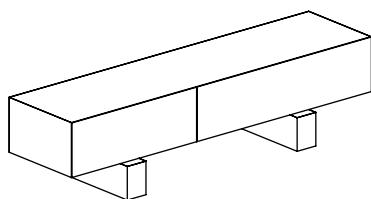

Structure

Structure, base and doors in 2,5 cm thick solidwood.

Finish

Heat treated woods as our samples and Swamp Oak oil finish based on natural wax and water.

Bottom-hinged mechanism for soft opening and closing.

Optional

Stone base L.15 cm.

1,2 cm thick solidwood trays

DIMENSIONS

240 cm x 60 cm x 61 cm h

280 cm x 60 cm x 61 cm h

Struttura

Scocca, basamento e ante in legno listellare spessore 2,5 cm.

Finitura

Legni termotrattati nelle finiture a campionario e rovere di palude, finiti ad olio a base di cera naturale e acqua.

Meccanismo a ribalta rallentato in apertura e chiusura in legno.

Optional

Basamento in pietra L.15 cm.

Vassoi interni in listellare SP. 1,5cm.

DIMENSIONI

240 cm x 60 cm x 61 cm h

280 cm x 60 cm x 61 cm h

Code . Codice	Thermowood Legni termizzati	Swamp oak Rovere di palude
Structure . Struttura		

Side . Credenza 240 x 60 x 61H

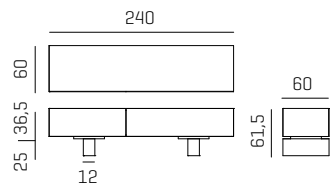

SIDE.SLIM01

8.498

9.950

Side . Credenza 280 x 60 x 61H

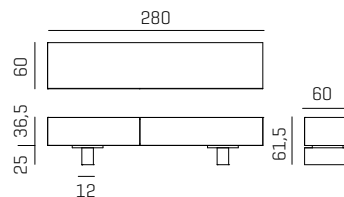

SIDE.SLIM02

9.046

10.746

Optional

Internal trays . Vassoi interni
L92,5 x H10 x PR50 cm

SIDE.ACC01

985

1.664

Maggiorazione per basamento in pietra L. 15 cm
Surcharge for stone base L. 15 cm

2.575

Slim Side Brass Ottone

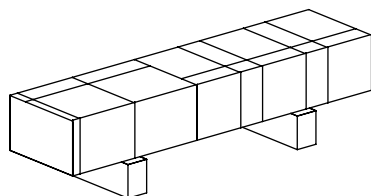

Code . Codice	Burnished brass Ottone brunito	Brushed brass . Ottone graffiato
Structure . Struttura		

Side . Credenza 240 x 60 x 61H

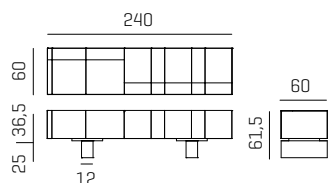

SIDE.SLIM01

15.091

15.683

Side . Credenza 280 x 60 x 61H

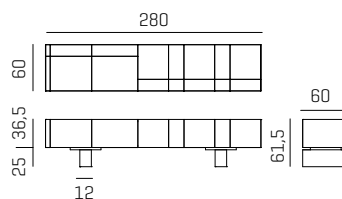

SIDE.SLIM02

15.846

16.640

24

Structure

Structure, base and doors in 2,5 cm thick solidwood.

Finish

Brass hand-burnished using traditional techniques.

internal black Eucalyptus Thermowood

Bottom-hinged mechanism for soft opening and closing.

Optional

Back in brass finish. Stone base L.15 cm.

1,5 cm thick solidwood trays

DIMENSIONS

240 cm x 60 cm x 61 cm h

280 cm x 60 cm x 61 cm h

Struttura

Scocca, basamento e ante in legno listellare spessore 2,5 cm.

Finitura

Ottone brunito a mano secondo le tecniche tradizionali

e ottone graffiato verniciato interno in eucalipto nero.

Meccanismo a ribalta rallentato in apertura e chiusura.

Optional

Finitura retro in ottone. Basamento in pietra L.15 cm.

Vassoi interni in listellare SP. 1,5cm.

DIMENSIONI

240 cm x 60 cm x 61 cm h

280 cm x 60 cm x 61 cm h

Optional

Internal trays . Vassoi interni
in legno termizzato
L92,5 x H10 x PR50 cm

SIDE.ACC01

985

Surcharge for the back in brass finish.

Maggiorazione per schiena
ottone finita retro L. 240

1.540

1.803

Surcharge for the back in brass finish.

Maggiorazione per schiena
ottone finita retro L. 280

1.716

2.027

Maggiorazione per basamento in pietra L. 15 cm

Surcharge for stone base L. 15 cm

2.575

Surcharge for black burnished brass 3% on top of the burnished brass price
Maggiorazione per finitura ottone brunito nero 3% del prezzo dell'ottone brunito

Maggiorazione per schiena finitura ottone brunito nero 3% on top of the burnished brass price
Surcharge for the back black burnished brass 3% del prezzo dell'ottone brunito

Slim Side High Wood Legno

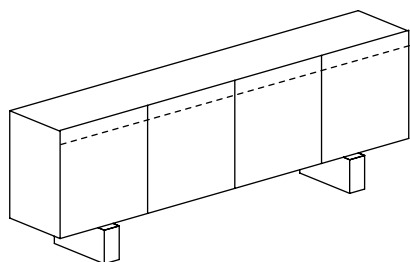

Structure

Structure, base and doors in 2,5 cm thick solidwood.

Finish

Heat treated woods as our samples and Swamp Oak oil finish based on natural wax and water.

Accessories inside

1,2 cm thick solidwood drawers

DIMENSIONS

240 cm x 48 cm x 95 cm h

280 cm x 48 cm x 95 cm h

Struttura

Scocca, basamento e ante in legno listellare spessore 2,5 cm.

Finitura

Legni termotrattati nelle finiture a campionario e rovere di palude, finiti ad olio a base di cera naturale e acqua.

Accessori interni

Cassetti in legno listellare sp 1,2 cm

DIMENSIONI

240 cm x 48 cm x 95 cm h

280 cm x 48 cm x 95 cm h

Code . Codice

Thermowood
Legni termizzati

Swamp oak
Rovere di palude

Structure . Struttura

Side . Credenza 240 x 48 x 95H

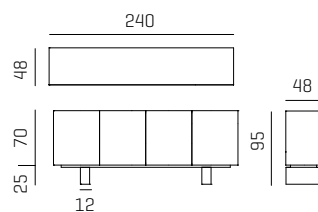

SIDE.SLIM03

7.305

9.444

Side . Credenza 280 x 48 x 95H

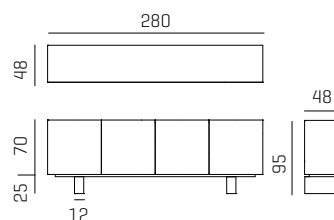

SIDE.SLIM04

8.720

11.046

Optional

Maggiorazione per basamento in pietra L. 15 cm
Surcharge for stone base L. 15 cm

2.575

Slim Side High Brass Ottone

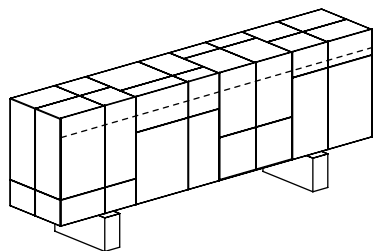

Side . Credenza 240 x 48 x 95H

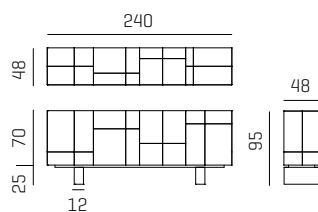

SIDE.SLIM03

16.722

17.351

Side . Credenza 280 x 48 x 95H

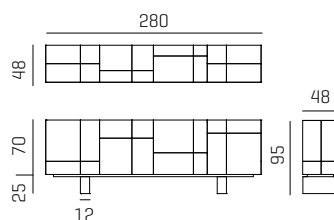

SIDE.SLIM04

18.601

19.863

26

Structure

Structure, base and n. 4 doors in 2,5 cm thick solidwood.

Finish

Brass hand-burnished using traditional techniques and brushed brass, internal in eucalipto nero.

Accessories inside

1,5 cm thick solidwood drawers

DIMENSIONS

240 cm x 48 cm x 95 cm h

280 cm x 48 cm x 95 cm h

Struttura

Scocca, basamento e n. 4 ante in legno listellare, spessore 2,5 cm.

Finitura

Ottone brunito a mano secondo le tecniche tradizionali e ottone graffiato verniciato, interno in eucalipto nero

Accessori interni

Cassetti interni in listellare SP.1,5 cm.

DIMENSIONI

240 cm x 48 cm x 95 cm h

280 cm x 48 cm x 95 cm h

Optional

Surcharge for the back in brass finish.

Maggiorazione per schiena ottone finita retro L. 240

1.716

1.980

Surcharge for the back in brass finish.

Maggiorazione per schiena ottone finita retro L. 280

1.936

2.200

Basamento in pietra L. 15 cm

Stone base L. 15 cm

2.575

Surcharge for black burnished brass 3%

Surcharge for the back black burnished brass 3%

Maggiorazione per finitura ottone brunito nero 3%

Maggiorazione per schiena finitura ottone brunito nero 3%

Code . Codice

Burnished brass .
Ottone brunito

Brushed brass .
Ottone graffiato

Structure . Struttura

Hypnose Sofa

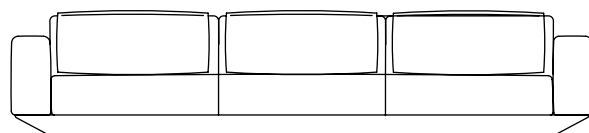

Two seater sofa . Divano 2 posti 248

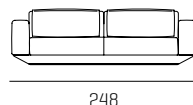

Two seater maxi sofa . Divano 2 posti maxi 288

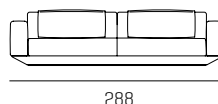

Three seater sofa . Divano 3 posti 348

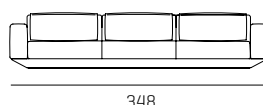

Three seater maxi sofa . Divano 3 posti maxi 408

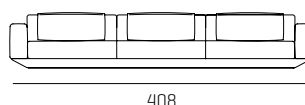

One seater element Lh . Elemento 1 posto 124 Sx

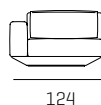

One seater element Rh . Elemento 1 posto 124 Dx

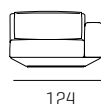

One seater maxi element Lh . Elemento 1 posto maxi 144 Sx

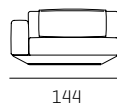

One seater maxi element Rh . Elemento 1 posto maxi 144 Dx

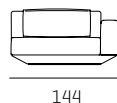

Two seater element Lh . Elemento 2 posti 224 Sx



SOFA.HYP001	6.650	9.458	10.502
-------------	-------	-------	--------

SOFA.HYP002	7.338	10.437	11.571
-------------	-------	--------	--------

SOFA.HYP003	8.922	12.657	14.063
-------------	-------	--------	--------

SOFA.HYP004	9.358	13.936	15.478
-------------	-------	--------	--------

SOFA.HYP037	3.506	4.989	5.535
-------------	-------	-------	-------

SOFA.HYP038	3.506	4.989	5.535
-------------	-------	-------	-------

SOFA.HYP039	3.792	5.421	6.011
-------------	-------	-------	-------

SOFA.HYP040	3.792	5.421	6.011
-------------	-------	-------	-------

SOFA.HYP015	5.922	8.345	9.252
-------------	-------	-------	-------

Structure

Norwegian conifer solidwood

Seat

Padding 75 % white duck down feather + 25 % polyester fiber
Seat: Polyurethane foam D/35 PFFR Density 35/m³ Capacity 2.3 kPa. Downproof cover 100 % white cotton

Back

Padding 100 % white duck down feather
Back: Polyurethane foam D/35 EM Density 35 kg/m³ Capacity 3.6 kPa. Back Filling: Polyurethane foam D/40 P Density 40 kg/m³ Capacity 8 kPa. Downproof cover 100 % white cotton

Armrest

Padding 75 % white duck down feather + 25 % polyester fiber
Armrest: Polyurethane foam D/35 EM Density 35/m³ Capacity 3.6 kPa. Armrest filling: Polyurethane foam D/40 P Density 40 kg/m³ Capacity 8 kPa. Downproof cover 100 % white cotton.

Base

2C coupled cover 5mm White

Cover

Range of leathers, Nappa leather and fabrics as per sample, additional cushions and decorations available in leather, Nappa leather as per sample or in natural fabrics as per sample collections.

Ottoman and chaise longue seats available with 2 different finish.

DIMENSIONS

100 x 78 h cm

H seat: 45 cm

Seat: L 100 / L. 120

Hypnose Sofa

Struttura

Listellare di conifera norvegese.

Seduta

Imbottitura 75 % piuma bianca + 25 % fibra di poliestere
Sedile poliuretano espanso D/35 elast PFFR densità 35/m³
portanza 2.3kPa. Rivestimento antipiuma 100 % cotone bianco.

Schienale

Imbottitura 100 % piuma bianca. Schienale Poliuretano espanso
D/35 EM densità 35 kg/m³ portanza 3.6 kPa. Tamponamenti
Poliuretano espanso D/40 P densità 40 kg/m³ portanza 8 kPa
Rivestimento antipiuma 100 % cotone bianco

Bracciolo

Imbottitura 75 % piuma bianca + 25 % fibra di poliestere
Bracciolo Poliuretano espanso D/35 EM densità 35 kg/m³ por-
tanza 3.6 kPa. Tamponamenti Poliuretano espanso D/40 P den-
sità 40 kg/m³ portanza 8 kPa
Rivestimento antipiuma 100 % cotone bianco

Basamento

Rivestimento accoppiato 2C 5mm Bianco

Rivestimenti

Gamma pelli, nappa e tessuti a campionario, cuscinate ag-
giuntive e decorative in pelle e nappa a campionario o nei tessuti
naturali delle collezioni a campionario. Le sedute dei pouf e delle
chaise longue possono avere 2 differenti finiture.

DIMENSIONI

100 x 78 h cm

H seduta: 38 cm

Seduta: L. 100 / L. 120

Two seater element Rh. Elemento 2 posti 224 Dx



SOFA.HYP016	5.922	8.345	9.252
-------------	-------	-------	-------

Two seater element Lh. Elemento 2 posti maxi 264 Sx

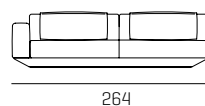

SOFA.HYP017	6.470	9.410	10.453
-------------	-------	-------	--------

Two seater element Rh. Elemento 2 posti maxi 264 Dx

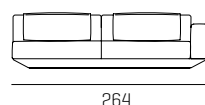

SOFA.HYP018	6.470	9.410	10.453
-------------	-------	-------	--------

Central element . Elemento centrale 100

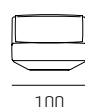

SOFA.HYP035	2.684	3.828	4.236
-------------	-------	-------	-------

Central maxi element . Elemento centrale maxi 120

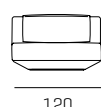

SOFA.HYP036	2.961	4.023	4.431
-------------	-------	-------	-------

Two seater element . Elemento 2 posti 200

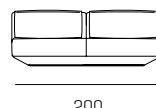

SOFA.HYP019	5.204	7.232	8.004
-------------	-------	-------	-------

Two seater element . Elemento 2 posti maxi 240

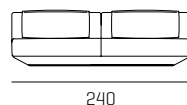

SOFA.HYP020	5.756	8.075	8.937
-------------	-------	-------	-------

Element Rh . Elemento angolo 200 Dx

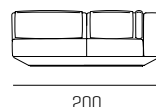

SOFA.HYP005	6.017	9.222	10.220
-------------	-------	-------	--------

Element Lh . Elemento angolo 200 Sx

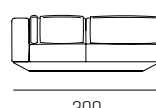

SOFA.HYP006	6.017	9.222	10.220
-------------	-------	-------	--------

Hypnose Sofa

Element Rh . Elemento angolo maxi 220 Dx

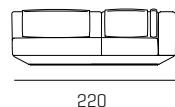

SOFA.HYP007	6.044	9.314	10.309
-------------	-------	-------	--------

Element Lh . Elemento angolo maxi 220 Sx

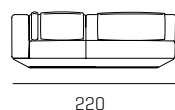

SOFA.HYP008	6.044	9.314	10.309
-------------	-------	-------	--------

Terminal element Lh. Elemento terminale 160 Sx

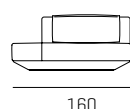

SOFA.HYP033	3.698	5.007	5.506
-------------	-------	-------	-------

Terminal element Rh. Elemento terminale 160 Dx

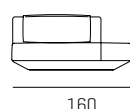

SOFA.HYP034	3.698	5.007	5.506
-------------	-------	-------	-------

Terminal element Rh. Elemento terminale 200 Dx

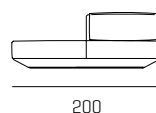

SOFA.HYP021	4.328	5.434	6.069
-------------	-------	-------	-------

Terminal element Lh. Elemento terminale 200 Sx

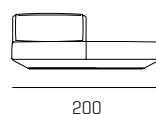

SOFA.HYP022	4.328	5.434	6.069
-------------	-------	-------	-------

Terminal element Rh . Elemento terminale 240 Dx

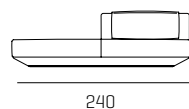

SOFA.HYP023	4.852	6.791	7.518
-------------	-------	-------	-------

Terminal element Lh . Elemento terminale 240 Sx

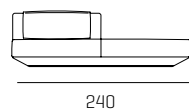

SOFA.HYP024	4.852	6.791	7.518
-------------	-------	-------	-------

Peninsula Maxi Lh. Penisola Maxi 144 Sx P. 140

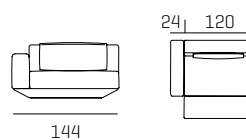

SOFA.HYP047	4.402	6.482	7.162
-------------	-------	-------	-------

Hypnose Sofa

Peninsula Maxi Rh. Penisola Maxi 144 Dx P. 140

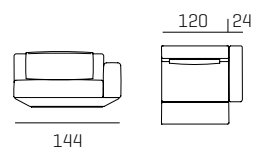

SOFA.HYP048	4.402	6.482	7.162
-------------	-------	-------	-------

Peninsula Maxi . Penisola Maxi 120 P. 140

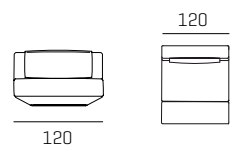

SOFA.HYP049	3.816	5.325	5.869
-------------	-------	-------	-------

Peninsula XL . Penisola XL 135 P. 140

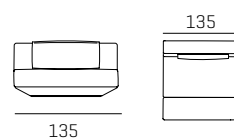

SOFA.HYP050	4.353	5.979	6.618
-------------	-------	-------	-------

Pouf . Pouf 100 P. 100



SOFA.HYP041	2.263	2.968	3.241
-------------	-------	-------	-------

Pouf Maxi . Pouf Maxi 120 P. 100



SOFA.HYP042	2.635	3.390	3.707
-------------	-------	-------	-------

Pouf XL Rh . Pouf XL 140 Dx P. 100

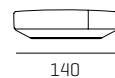

SOFA.HYP043	2.653	3.757	4.120
-------------	-------	-------	-------

Pouf XL Lh . Pouf XL 140 Sx P. 100

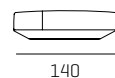

SOFA.HYP044	2.653	3.757	4.120
-------------	-------	-------	-------

Pouf XXL Rh . Pouf XXL 160 Dx P. 100

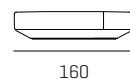

SOFA.HYP045	3.164	4.599	5.053
-------------	-------	-------	-------

Pouf XXL Lh . Pouf XXL 160 Sx P. 100

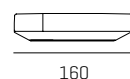

SOFA.HYP046	3.164	4.599	5.053
-------------	-------	-------	-------

O-One Sofa

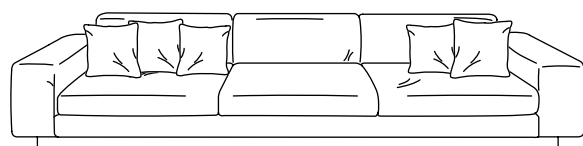

Structure

Multilayered Norwegian pine.

Padding

Back and arm rests: cover fabric 100% white cotton. Filler: 50% goose down feather and 50% silicone flakes, polyurethane T40 PK + T35 S
Seat cushions: cover fabric 100% white cotton, inner fabric 65% polyester 35% cotton.

Filler: 100% goose and duck down feather, polyurethane T40 PFM
Back cushions: cover fabric resin-treated 100gr, 100% white cotton, inner fabric 65% polyester 35% cotton.

Filler: 50% goose down feather and 50% silicone flakes, polyurethane T40 TD

Base: cover fabric 100% white cotton.

Filler: 50% goose down feather and 50% silicone flake.

Upholstery

Range of leather, nappa and other fabrics as per samples, extra decorative cushions in leather and nappa as per samples or in natural fabrics from the sample collections.

Metal Base

Hand burnished black steel base made using traditional techniques.

Hand burnished brass base made using traditional techniques.

DIMENSIONS









110 cm x 70 h cm

H seat: 37 cm

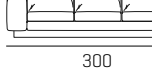
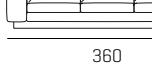
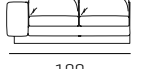
H base: 8 cm

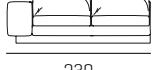
NB: Right/Dx and Left/Sx indicate the position of the armrest, when looking at the piece of furniture from the front.

NB: Per Dx e Sx si intende la posizione che il bracciolo assume guardando l'elemento.

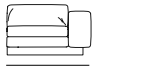
	Finish of base Finitura basamento	Code . Codice	Fabric Tessuto	Leather . Pelle cat. 300	Leather . Pelle cat. 400
Two-seater sofa . Divano 2 posti 220					
 220	Burnished steel Acciaio brunito	ONE.ONE001	5.455	7.793	8.683
	Burnished Brass Ottone brunito		5.822	8.160	9.050
Two-seater maxi sofa . Divano 2 posti maxi 260					
 260	Burnished steel Acciaio brunito	ONE.ONE002	6.121	8.352	9.266
	Burnished Brass Ottone brunito		6.510	8.741	9.655
Three-seater sofa . Divano 3 posti 300					
 300	Burnished steel Acciaio brunito	ONE.ONE003	7.237	10.283	11.434
	Burnished Brass Ottone brunito		7.649	10.696	11.845
Three-seater maxi sofa . Divano 3 posti maxi 360					
 360	Burnished steel Acciaio brunito	ONE.ONE004	8.309	11.310	12.571
	Burnished Brass Ottone brunito		8.755	11.778	13.017
Two-seater element Lh . Elemento 2 posti 190 Sx					
 190	Burnished steel Acciaio brunito	ONE.ONE005	4.831	6.808	7.569
	Burnished Brass Ottone brunito		5.199	7.174	7.935
Two-seater element Rh . Elemento 2 posti 190 Dx					
 190	Burnished steel Acciaio brunito	ONE.ONE006	4.831	6.808	7.569
	Burnished Brass Ottone brunito		5.199	7.174	7.935
Two-seater large element Lh . Elemento 2 posti maxi 230 Sx					
 230	Burnished steel Acciaio brunito	ONE.ONE007	5.270	7.201	7.962
	Burnished Brass Ottone brunito		5.660	7.590	8.352
Two-seater large element Rh . Elemento 2 posti maxi 230 Dx					
 230	Burnished steel Acciaio brunito	ONE.ONE008	5.270	7.201	7.962
	Burnished Brass Ottone brunito		5.660	7.590	8.352
One seater element Lh . Elemento 1 posto 110 Sx					
 110	Burnished steel Acciaio brunito	ONE.ONE009	2.851	4.012	4.458
	Burnished Brass Ottone brunito		3.024	4.183	4.629
One seater element Rh . Elemento 1 posto 110 Dx					
 110	Burnished steel Acciaio brunito	ONE.ONE010	2.851	4.012	4.458
	Burnished Brass Ottone brunito		3.024	4.183	4.629
One seater large element Lh . Modulo finale maxi 130 Sx					
 130	Burnished steel Acciaio brunito	ONE.ONE011	3.173	4.290	4.750
	Burnished Brass Ottone brunito		3.356	4.488	4.934
One seater large element Rh . Modulo finale maxi 130 Dx					
 130	Burnished steel Acciaio brunito	ONE.ONE012	3.173	4.290	4.750
	Burnished Brass Ottone brunito		3.356	4.488	4.934

Struttura

Listellare di conifera norvegese.

Imbottitura

Schienale e bracciolo tessuto esterno 100% cotone bianco.

Interno: 50% piuma d'oca e 50% fiocco siliconato, poliuretano T40 PK + T35 S.

Seduta: esterno tessuto 100% cotone bianco, tessuto interno 65% poliestere 35% cotone.

Interno 100% piuma d'oca, d'anatra, poliuretano T40 PFM.

Cuscino schienale: tessuto esterno 100% cotone bianco resinato 100 gr.

Tessuto interno 65% poliestere 35% cotone.

Interno 50% piuma d'oca, d'anatra, poliuretano T40 TD.

Basamento: tessuto esterno 100% cotone bianco.

Interno 50% piuma d'oca e 50% fiocco siliconato.

Rivestimenti

Gamma pelli, nappa e tessuti a campionario, cuscinate aggiuntive e decorative in pelle e nappa a campionario o nei tessuti naturali delle collezioni a campionario.

Basamento Metallo

Acciaio brunito nero a mano secondo le tecniche tradizionali.

Ottone brunito a mano secondo le tecniche tradizionali.

DIMENSIONI

110 cm x 70 h cm

H seduta: 37 cm

H base: 8 cm

Finish of base Finitura basamento	Code . Codice	Fabric Tessuto	Leather . Pelle cat. 300	Leather . Pelle cat. 400
--------------------------------------	---------------	-------------------	-----------------------------	-----------------------------

Central element . Elemento centrale 80



80

Burnished steel Acciaio brunito	ONE.ONE013	2.235	3.084	3.423
Burnished Brass Ottone brunito		2.396	3.244	3.583

Central maxi element . Elemento centrale maxi 100



100

Burnished steel Acciaio brunito	ONE.ONE014	2.511	3.335	3.674
Burnished Brass Ottone brunito		2.693	3.517	3.856

Penisola Lh . Penisola 110 x 180 Sx

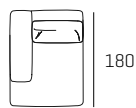

110

Burnished steel Acciaio brunito	ONE.ONE015	4.386	6.173	6.859
Burnished Brass Ottone brunito		4.753	6.539	7.225

Penisola Rh . Penisola 110 x 180 Dx

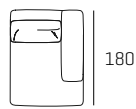

110

Burnished steel Acciaio brunito	ONE.ONE016	4.386	6.173	6.859
Burnished Brass Ottone brunito		4.753	6.539	7.225

Penisola maxi Lh . Penisola maxi 130 x 180 Sx

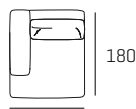

130

Burnished steel Acciaio brunito	ONE.ONE017	4.882	6.623	7.309
Burnished Brass Ottone brunito		5.249	6.889	7.675

Penisola maxi Rh . Penisola maxi 130 x 180 Dx

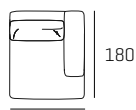

130

Burnished steel Acciaio brunito	ONE.ONE018	4.882	6.623	7.309
Burnished Brass Ottone brunito		5.249	6.889	7.675

Corner . Angolo 110 x 110

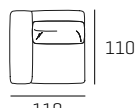

110

Burnished steel Acciaio brunito	ONE.ONE019	3.565	5.015	5.573
Burnished Brass Ottone brunito		3.736	5.187	7.675

Large pouff . Pouff grande 100 x 110



100

Burnished steel Acciaio brunito	ONE.ONE020	1.865	2.058	2.183
Burnished Brass Ottone brunito		2.094	2.287	2.414

Pouff 80x110



80

Burnished steel Acciaio brunito	ONE.ONE021	1.540	1.760	1.889
Burnished Brass Ottone brunito		1.746	1.967	2.095

Cushion . Cuscinello 45 x 45



45

-	ONE.ONE022	335	372	377
---	------------	-----	-----	-----

NB: Right/Dx and Left/Sx indicate the position of the armrest, when looking at the piece of furniture from the front.

NB: per Dx e Sx si intende la posizione che il bracciolo assume guardando l'elemento.

X-One Sofa

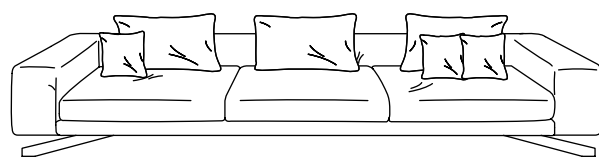

Structure

Multilayered Norwegian pine.

Padding

Back and arm rests: cover fabric 100% white cotton, filler 50% goose down feather and 50% silicone flake, polyurethane T40 PK + T35 S.

Seat cushions: cover fabric 100% white cotton, inner fabric 65% polyester 35% cotton.

Filler: 100% goose and duck down feather, polyurethane T40 PFM. Back cushions: cover fabric resin-treated 100gr, 100% white cotton, inner fabric 65% polyester 35% cotton.

Filler: 50% goose down feather and 50% silicone flake, polyurethane T40 TD.

Base: cover fabric 100% white cotton.

Filler: 50% goose down feather and 50% silicone flake.

Upholstery

Range of leather, nappa and fabrics as per samples, extra decorative cushions in leather and nappa as per samples or in natural fabrics from the sample collections.

Metal Base

Hand burnished black steel base made using traditional techniques.

DIMENSIONS

110 cm x 70 h cm

H seat: 37 cm

H base: 14 cm

NB: Right/Dx and Left/Sx indicate the position of the armrest, when looking at the piece of furniture from the front. A matching 55x75 cm pillow is included for each chair.

NB: Per Dx e Sx si intende la posizione che il bracciolo assume guardando l'elemento. Per ogni seduta viene incluso nel prezzo un cuscino 55 x 75 cm della stessa.

Finishes . Finitura	Code . Codice	Fabric Tessuto	Leather . Pelle cat. 300	Leather . Pelle cat. 400
---------------------	---------------	----------------	--------------------------	--------------------------

Two seater sofa . Divano 2 posti 220

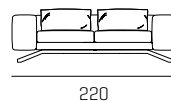

Burnished steel Acciaio brunito	ONE.XONE01	6.872	9.161	9.979
------------------------------------	------------	-------	-------	-------

Two seater maxi sofa . Divano 2 posti maxi 260

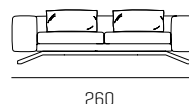

Burnished steel Acciaio brunito	ONE.XONE02	7.381	9.707	10.716
------------------------------------	------------	-------	-------	--------

Three seater sofa . Divano 3 posti 300



Burnished steel Acciaio brunito	ONE.XONE03	9.140	12.186	13.249
------------------------------------	------------	-------	--------	--------

Three seater maxi sofa . Divano 3 posti maxi 360

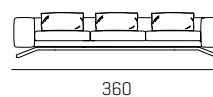

Burnished steel Acciaio brunito	ONE.XONE04	9.654	12.780	14.151
------------------------------------	------------	-------	--------	--------

Two seater element Lh . Elemento 2 posti 190 Sx

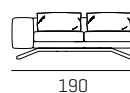

Burnished steel Acciaio brunito	ONE.XONE05	6.033	7.960	8.785
------------------------------------	------------	-------	-------	-------

Two seater element Rh . Elemento 2 posti 190 Dx

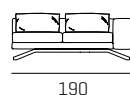

Burnished steel Acciaio brunito	ONE.XONE06	6.033	7.960	8.785
------------------------------------	------------	-------	-------	-------

Two seater large element Lh . Elemento 2 posti maxi 230 Sx

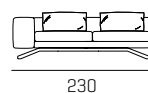

Burnished steel Acciaio brunito	ONE.XONE07	6.426	8.226	9.050
------------------------------------	------------	-------	-------	-------

Two seater large element Rh . Elemento 2 posti maxi 230 Dx

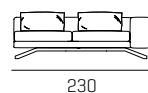

Burnished steel Acciaio brunito	ONE.XONE08	6.426	8.226	9.050
------------------------------------	------------	-------	-------	-------

Large pouff . Pouff grande 100 x 110



Burnished steel Acciaio brunito	ONE.XONE12	3.032	3.799	4.165
------------------------------------	------------	-------	-------	-------

Struttura

Listellare di conifera norvegese.

Imbottitura

Schienale e bracciolo: tessuto esterno 100% cotone bianco, interno 50% piuma d'oca e 50% fiocco siliconato, poliuretano T40 PK + T35 S. Seduta: tessuto esterno 100% cotone bianco, tessuto interno 65% poliestere 35% cotone.

Interno: 100% piuma d'oca, d'anatra, poliuretano T40 PFM.

Cuscino schienale: tessuto esterno 100% cotone bianco resinato 100 gr, tessuto interno 65% poliestere 35% cotone.

Interno 50% piuma d'oca e 50% fiocco siliconato, poliuretano T40 TD. Basamento tessuto esterno 100% cotone bianco.

Interno 50% piuma d'oca e 50% fiocco siliconato.

Rivestimenti

Gamma pelli, nappa e tessuti a campionario, cuscinature aggiuntive e decorative in pelle e nappa a campionario o nei tessuti naturali delle collezioni a campionario.

Basamento Metallo

Acciaio brunito nero a mano secondo le tecniche tradizionali.

DIMENSIONI

110 cm x 70 cm

H seduta: 37 cm

H base: 14 cm

Finishes . Finitura	Code . Codice	Fabric Tessuto	Leather . Pelle cat. 300	Leather . Pelle cat. 400
---------------------	---------------	----------------	--------------------------	--------------------------

Large element Lh . Modulo isola large 130 x 130 Sx



130

Burnished steel Acciaio brunito	ONE.XONE09	4.744	6.318	7.051
------------------------------------	------------	-------	-------	-------

Large element Rh . Modulo isola large 130 x 130 Dx



130

Burnished steel Acciaio brunito	ONE.XONE10	4.744	6.318	7.051
------------------------------------	------------	-------	-------	-------

Central island element . Modulo centrale isola 100 x 130



100

Burnished steel Acciaio brunito	ONE.XONE11	3.473	4.241	4.608
------------------------------------	------------	-------	-------	-------

Cushion . Cuscinello 45 x 45



45

-	ONE.ONE22	335	372	377
---	-----------	-----	-----	-----

NB: Right/Dx and Left/Sx indicate the position of the armrest, when looking at the piece of furniture from the front. A matching 55x75cm pillow is included for each chair.

NB: Per Dx e Sx si intende la posizione che il bracciolo assume guardando l'elemento. Per ogni seduta viene incluso nel prezzo un cuscino 55 x 75 cm della stessa

S-Day Bed



Structure

Norwegian softwood solidwood.

Padding

280 gr Tecnoform jet backed with 200 gr resin sheet and down feather. Backrest cushions and arms cushions padded in D/21 SM. Polyurethane foam backed with 200 gr resin sheet and down. Seat with under-seat in D/30 E polyurethane foam, seat top in D/30 EET polyurethane foam, covered with a pad in D/40 PF polyurethane foam, seat front with 300 gr. lap strip. Edge to edge seams on leather and nappa upholstery.

Upholstery

Leather or nappa from our range, additional and decorative cushions in leather or nappa from our range, or in natural fabrics from the collections. The fabric version as a perimetric lap-felled seam.

DIMENSIONS

180/120 cm x 35 cm

Struttura

Listellare di conifera norvegese.

Imbottitura

Tecnoform jet 280 gr accoppiato a resinato 200 gr. Imbottitura di cuscini schienale e bracciolo realizzati in poliuretano espanso D/21. SM Rivestimento tecnoform jet 280 gr accoppiato a resinato 200 gr e piuma. Seduta con sotto sedile realizzato in poliuretano espanso D/30 E, sopra sedile realizzato in poliuretano espanso D/30 EET, tampone sopra seduta realizzato in poliuretano espanso D/40 PF, frontale seduta fascia falda 300 gr Pelle e nappa di rivestimento in finitura a taglio vivo.

Rivestimenti

Gamma pelli, nappa e tessuti a campionario, cuscinate aggiuntive e decorative in pelle e nappa a campionario o nei tessuti naturali delle collezioni a campionario. La versione in tessuto ha la cucitura con ribattuta perimetrale.

DIMENSIONI

180/120 cm x 35 cm

S-Day Bed 180x120

Leather . Pelle

DIAM.DBS01

3.113

4.151

4.419

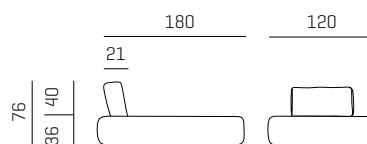

S-Day Bed 120x120

Leather . Pelle

DIAM.DBS02

2.426

3.205

3.367

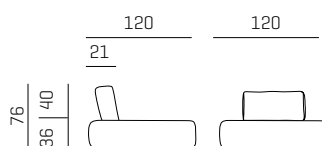

S-Perla Sofa

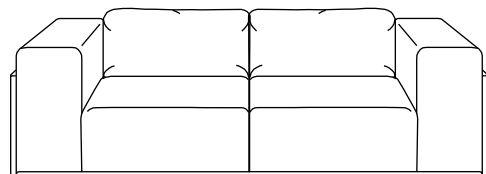

Structure

Norwegian softwood solidwood.

Padding

280 gr Tecnoform jet backed with 200 gr resin sheet.

Backrest cushions and arms cushions padded in D/21 SM.

Polyurethane foam backed with 200 gr resin sheet and down feather. Seat with under-seat in D/30 E polyurethane foam, seat top in D/30 EET polyurethane foam, covered with a pad in D/40 PF polyurethane foam, seat front with 300 gr lap strip. Edge to edge seams on leather and nappa upholstery.

Upholstery

Leather or nappa from our range, additional and decorative cushions in leather or nappa from our range, or in natural fabrics from the collections. The fabric version as a perimetric lap-felled seam.

DIMENSIONS

110 cm x 70 cm H

H seat: 40 cm

Struttura

Listellare di conifera norvegese.

Imbottitura

Tecnoform jet 280 gr accoppiato a resinato 200 gr.

Imbottitura di cuscini schienale e bracciolo realizzati in poliuretano espanso D/21 SM.

Rivestimento tecnoform jet 280 gr accoppiato a resinato 200 gr e piuma. Seduta con sotto sedile realizzato in poliuretano espanso D/30 E, sopra sedile realizzato in poliuretano espanso D/30 EET, tampone sopra seduta realizzato in poliuretano espanso D/40 PF, frontale seduta fascia falda 300 gr.

Pelle e nappa di rivestimento in finitura a taglio vivo.

Rivestimenti

Gamma pelli, nappa e tessuti a campionario, cuscinate aggiuntive e decorative in pelle e nappa a campionario o nei tessuti naturali delle collezioni a campionario. La versione in tessuto ha la cucitura con ribattuta perimetrale.

DIMENSIONI

110 cm x 70 cm H

H seduta: 40 cm

NB: Right/Dx and Left/Sx indicate the position of the armrest, when looking at the piece of furniture from the front.

NB: Per Dx e Sx si intende la posizione che il bracciolo assume guardando l'elemento.

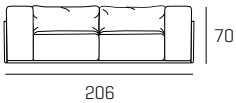
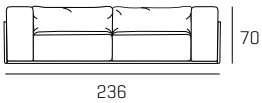
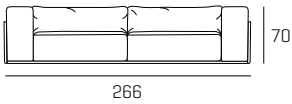
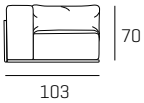
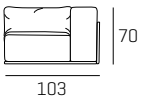
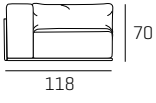
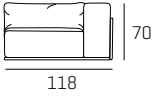
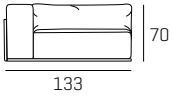
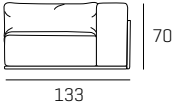
	Finishes . Finitura	Code . Codice	Fabric Tessuto	Leather . Pelle cat. 300	Leather . Pelle cat. 400
Two-seater sofa 206 Divano 2 posti	Leather . Pelle	DIAM.SPER029	4.785	6.381	6.984
					
Three-seater sofa 236 Divano 3 posti	Leather . Pelle	DIAM.SPER048	5.177	6.904	7.594
					
Three-seater maxi sofa 266 Divano 3 posti maxi	Leather . Pelle	DIAM.SPER049	5.595	7.461	8.208
					
One-seater element 103 LH Elemento 1 posto	Leather . Pelle	DIAM.SPER001	2.368	3.157	3.473
					
One-seater element 103 RH Elemento 1 posto	Leather . Pelle	DIAM.SPER002	2.368	3.157	3.473
					
One-seater element 118 LH Elemento 1 posto	Leather . Pelle	DIAM.SPER006	2.567	3.421	3.764
					
One-seater element 118 RH Elemento 1 posto	Leather . Pelle	DIAM.SPER007	2.567	3.421	3.764
					
One-seater element 133 LH Elemento 1 posto	Leather . Pelle	DIAM.SPER010	2.773	3.698	4.067
					
One-seater element 133 RH Elemento 1 posto	Leather . Pelle	DIAM.SPER011	2.773	3.698	4.067
					

HENGE®

S-Perla Sofa

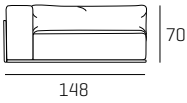
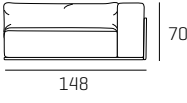
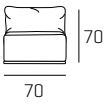
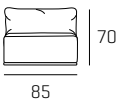
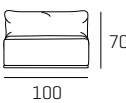
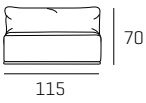
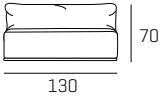
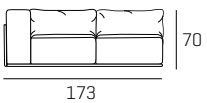
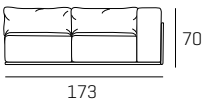
	Finishes . Finitura	Code . Codice	Fabric Tessuto	Leather . Pelle cat. 300	Leather . Pelle cat. 400
One-seater element 148 LH Elemento 1 posto	Leather . Pelle	DIAM.SPER012	3.030	4.040	4.443
					
One-seater element 148 RH Elemento 1 posto	Leather . Pelle	DIAM.SPER013	3.030	4.040	4.443
					
Central element 70 Elemento centrale	Leather . Pelle	DIAM.SPER003	1.405	1.872	2.059
					
Central element 85 Elemento centrale	Leather . Pelle	DIAM.SPER004	1.571	2.095	2.303
					
Central element 100 Elemento centrale	Leather . Pelle	DIAM.SPER005	1.777	2.369	2.607
					
Central element 115 Elemento centrale	Leather . Pelle	DIAM.SPER008	1.967	2.627	2.891
					
Central element 130 Elemento centrale	Leather . Pelle	DIAM.SPER009	2.243	2.998	3.288
					
Two-seater element 173 LH Elemento 2 posti	Leather . Pelle	DIAM.SPER027	3.288	5.069	5.577
					
Two-seater element 173 RH Elemento 2 posti	Leather . Pelle	DIAM.SPER028	3.288	5.069	5.577
					

NB: Right/Dx and Left/Sx indicate the position of the armrest, when looking at the piece of furniture from the front.
NB: Per Dx e Sx si intende la posizione che il bracciolo assume guardando l'elemento.

S-Perla Sofa

Finishes . Finitura	Code . Codice	Fabric Tessuto	Leather . Pelle cat. 300	Leather . Pelle cat. 400
---------------------	---------------	----------------	--------------------------	--------------------------

Two-seater element 203 LH
Elemento 2 posti

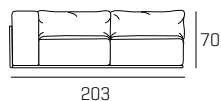

Leather . Pelle	DIAM.SPER034	4.161	5.548	6.102
-----------------	--------------	-------	-------	-------

Two-seater element 203 RH
Elemento 2 posti

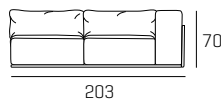

Leather . Pelle	DIAM.SPER035	4.161	5.548	6.102
-----------------	--------------	-------	-------	-------

Three-seater element 233 LH
Elemento 3 posti

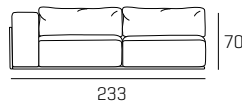

Leather . Pelle	DIAM.SPER036	4.577	6.103	6.714
-----------------	--------------	-------	-------	-------

Three-seater element 233 RH
Elemento 3 posti

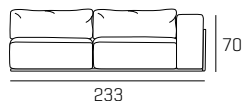

Leather . Pelle	DIAM.SPER037	4.577	6.103	6.714
-----------------	--------------	-------	-------	-------

Three-seater element 263 LH
Elemento 3 posti

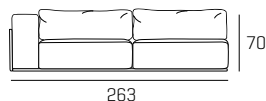

Leather . Pelle	DIAM.SPER038	5.146	6.792	7.375
-----------------	--------------	-------	-------	-------

Three-seater element 263 RH
Elemento 3 posti

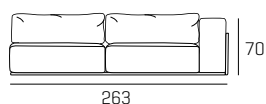

Leather . Pelle	DIAM.SPER039	5.146	6.792	7.375
-----------------	--------------	-------	-------	-------

Peninsula . Penisola 103 Sx

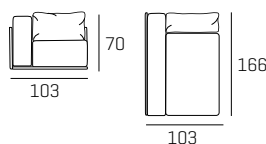

Leather . Pelle	DIAM.SPER030	3.604	4.805	5.285
-----------------	--------------	-------	-------	-------

Peninsula . Penisola 103 Dx

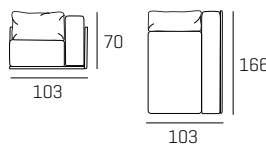

Leather . Pelle	DIAM.SPER031	3.604	4.805	5.285
-----------------	--------------	-------	-------	-------

NB: Right/Dx and Left/Sx indicate the position of the armrest, when looking at the piece of furniture from the front.
NB: Per Dx e Sx si intende la posizione che il bracciolo assume guardando l'elemento.

S-Perla Sofa

	Finishes . Finitura	Code . Codice	Fabric Tessuto	Leather . Pelle cat. 300	Leather . Pelle cat. 400
<p>Peninsula . Penisola 133 Sx</p> 	Leather . Pelle	DIAM.SPER032	3.989	5.320	5.851
<p>Peninsula . Penisola 133 Dx</p> 	Leather . Pelle	DIAM.SPER033	3.989	5.320	5.851
<p>Pouf 103x103</p> 	Leather . Pelle	DIAM.SPER054	1.594	1.667	1.834
<p>Pouf 70x103</p> 	Leather . Pelle	DIAM.SPER055	1.139	1.354	1.491
		Code . Codice	Fabric Tessuto	Leather . Pelle cat. 300	Leather . Pelle cat. 400
<p>Loose cushion . Cuscinello 30x30</p> 		TEXT.PILL01	200	228	245
<p>Loose cushion . Cuscinello 40x40</p> 		TEXT.PILL02	212	272	301
<p>Loose cushion . Cuscinello 60x40</p> 		TEXT.PILL04	234	340	374

NB: Right/Dx and Left/Sx indicate the position of the armrest, when looking at the piece of furniture from the front.
 NB: Per Dx e Sx si intende la posizione che il bracciolo assume guardando l'elemento.

Octagon Table

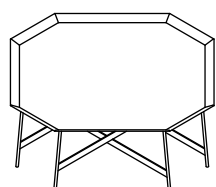
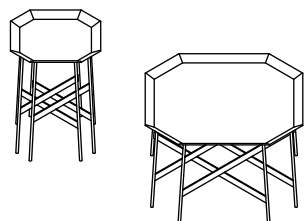

40

Structure

Ø 1 cm rod shape top

Finish

Black steel hand-burnished using traditional techniques.

Brass hand-burnished using traditional techniques.

DIMENSIONI

90 cm x 90 cm x 30 cm

70 cm x 70 cm x 40 cm

40 cm x 40 cm x 50 cm

Struttura

Tondino Ø 1 cm

Piano in lamiera sagomato

Finitura

Acciaio brunito nero a mano secondo le tecniche tradizionali.

Ottone brunito a mano secondo le tecniche tradizionali.

DIMENSIONI

90 cm x 90 cm x 30 cm

70 cm x 70 cm x 40 cm

40 cm x 40 cm x 50 cm

Octagon Table . Tavolo h. 50

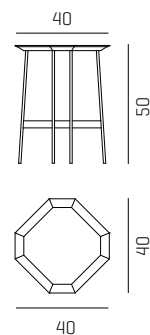

TABLE.OCTAG01

1.031

1.949

Octagon Table . Tavolo h. 40

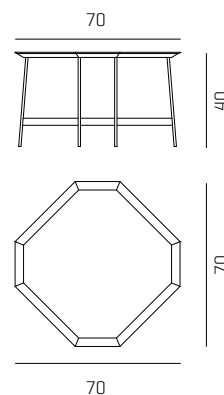

TABLE.OCTAG02

1.274

2.246

Octagon Table . Tavolo h. 30

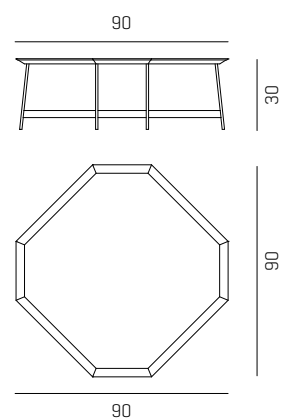
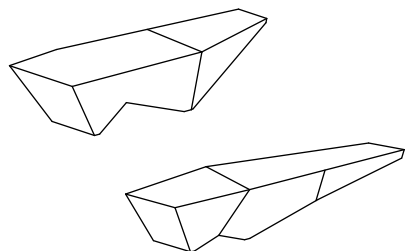

TABLE.OCTAG03

1.341

2.533

Monolith Table



Monolith Table . Tavolo h. 34

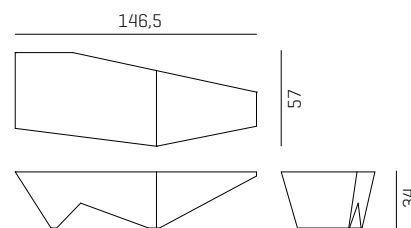

TABLE.MONOLO1

9.497

11.384

Monolith Table . Tavolo h. 30

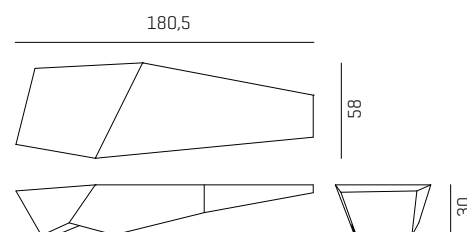

TABLE.MONOLO2

10.515

12.480

Structure

Internal structure in polyurethane foam,
Density 150Kg/m³, with inserts of plywood.

Finish

Brushed brass.

DIMENSIONS

146,5 cm x 57 cm x 34 cm

180,5 cm x 58 cm x 30 cm

Struttura

Anima interna in poliuretano espanso
D. 150 Kg/m³ con inseriti fogli di compensato.

Finitura

Ottone graffiato.

DIMENSIONI

146,5 cm x 57 cm x 34 cm

180,5 cm x 58 cm x 30 cm

Surcharge for black burnished brass 3%
Maggiorazione per finitura ottone brunito nero 3%

Network Table

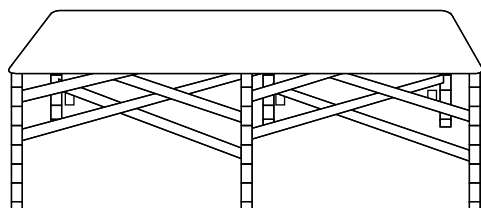

Frame

4 cm diameter brass tube intertwined with a rectangular brass tube

Finish

Brass hand-burnished using traditional techniques.

Tops

Solidwood, shaped, thickness 2,6 cm.

Finish

Heat treated woods as our samples and Swamp Oak

oil finish based on natural wax and water.

Burnished steel mesh tweed pattern.

DIMENSIONS

130 cm x 70 cm x 40 cm
160 cm x 70 cm x 40 cm
110 cm x 100 cm x 40 cm
160 cm x 50 cm x 60 cm
200 cm x 50 cm x 60 cm
160 cm x 50 cm x 81 cm
200 cm x 50 cm x 81 cm

Struttura

Tubolare in ottone di diametro 4 cm, con intreccio di tubo rettangolare in ottone.

Finitura

Ottone brunito a mano secondo le tecniche tradizionali.

Top

Legno listellare sagomato spessore 2,6 cm.

Finitura

Legni termotrattati nelle finiture a campionario e rovere di palude, finiti ad olio a base di cera naturale e acqua.

Maglia di acciaio tweed brunita.

DIMENSIONS

130 cm x 70 cm x 40 cm
160 cm x 70 cm x 40 cm
110 cm x 100 cm x 40 cm
160 cm x 50 cm x 60 cm
200 cm x 50 cm x 60 cm
160 cm x 50 cm x 81 cm
200 cm x 50 cm x 81 cm

Network 130 x 70

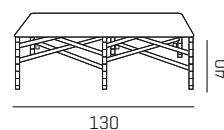

Network 180 x 70

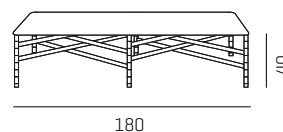

Network 110 x 100

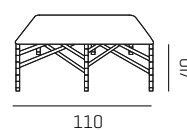

Oak Thermowood Rovere termizzato	TABLE.NET001	3.242
Eucalyptus Thermowood Eucalipto termizzato		
Black Eucalyptus Thermowood Eucalipto nero termizzato		
Acacia Thermowood Acacia termizzato		
Swamp oak Rovere di palude		3.757
Steel mesh tweed pattern Maglia di acciaio brunito Tweed		4.153

Oak Thermowood Rovere termizzato	TABLE.NET002	3.329
Eucalyptus Thermowood Eucalipto termizzato		
Black Eucalyptus Thermowood Eucalipto nero termizzato		
Acacia Thermowood Acacia termizzato		
Swamp oak Rovere di palude		3.905
Steel mesh tweed pattern Maglia di acciaio brunito Tweed		4.494

Oak Thermowood Rovere termizzato	TABLE.NET003	3.288
Eucalyptus Thermowood Eucalipto termizzato		
Black Eucalyptus Thermowood Eucalipto nero termizzato		
Acacia Thermowood Acacia termizzato		
Swamp oak Rovere di palude		3.795
Steel mesh tweed pattern Maglia di acciaio brunito Tweed		4.313

Surcharge for black burnished brass 5%
Maggiorazione per finitura ottone brunito nero 5%

Network Table

NETWORK SOFA BACK H.60 NETWORK RETRODIVANO H.60

Network 160 x 50

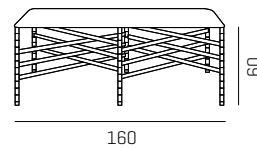

Oak Thermowood Rovere termizzato	TABLE.NET004	4.342
Eucalyptus Thermowood Eucalipto termizzato		
Black Eucalyptus Thermowood Eucalipto nero termizzato		
Acacia Thermowood Acacia termizzato		
Swamp oak Rovere di palude		4.714
Steel mesh tweed pattern Maglia di acciaio brunito Tweed		5.220

Surcharge for black burnished brass 5%
Maggiorazione per finitura ottone brunito nero 5%

Network 200 x 50

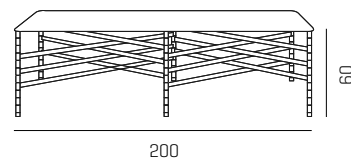

Oak Thermowood Rovere termizzato	TABLE.NET005	4.396
Eucalyptus Thermowood Eucalipto termizzato		
Black Eucalyptus Thermowood Eucalipto nero termizzato		
Acacia Thermowood Acacia termizzato		
Swamp oak Rovere di palude		4.853
Steel mesh tweed pattern Maglia di acciaio brunito Tweed		5.418

Surcharge for black burnished brass 5%
Maggiorazione per finitura ottone brunito nero 5%

NETWORK CONSOLLE H.81

Network 160 x 50

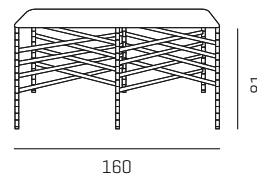

Oak Thermowood Rovere termizzato	TABLE.NET006	5.844
Eucalyptus Thermowood Eucalipto termizzato		
Black Eucalyptus Thermowood Eucalipto nero termizzato		
Acacia Thermowood Acacia termizzato		
Swamp oak Rovere di palude		6.216
Steel mesh tweed pattern Maglia di acciaio brunito Tweed		6.723

Surcharge for black burnished brass 5%
Maggiorazione per finitura ottone brunito nero 5%

Network 200 x 50

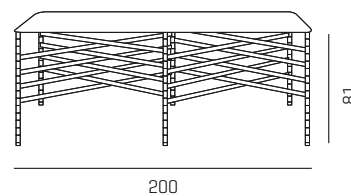

Oak Thermowood Rovere termizzato	TABLE.NET007	5.898
Eucalyptus Thermowood Eucalipto termizzato		
Black Eucalyptus Thermowood Eucalipto nero termizzato		
Acacia Thermowood Acacia termizzato		
Swamp oak Rovere di palude		6.354
Steel mesh tweed pattern Maglia di acciaio brunito Tweed		6.920

Surcharge for black burnished brass 5%
Maggiorazione per finitura ottone brunito nero 5%

Nomad Table

Top . Piano 65 x 100

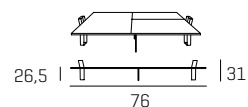

Gray Stone Smooth Gray Stone levigato	TABLE.NOM01	2.610
Cappuccino sanded Cappuccino sabbaiato		3.122
Egeo Black fantasy Renoir Meterous		
Hand decorated lava Lava cotta decorata a mano		3.368

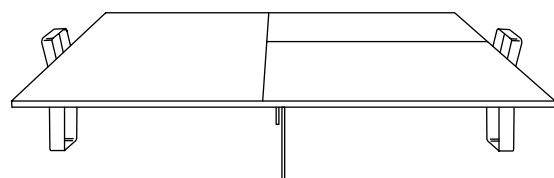

Top . Piano 100 x 100

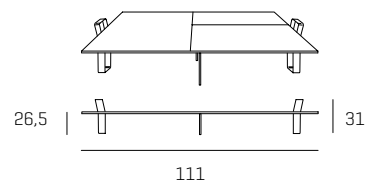

Gray Stone Smooth Gray Stone levigato	TABLE.NOM02	2.992
Cappuccino sanded Cappuccino sabbaiato		3.772
Egeo Black fantasy Renoir Meterous		
Hand decorated lava Lava cotta decorata a mano		4.559

Top . Piano 130 x 100

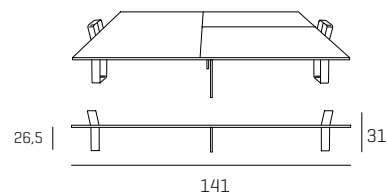

Gray Stone Smooth Gray Stone levigato	TABLE.NOM03	3.274
Cappuccino sanded Cappuccino sabbaiato		4.301
Egeo Black fantasy Renoir Meterous		
Hand decorated lava Lava cotta decorata a mano		5.573

Structure

Black steel hand-burnished using traditional techniques.
Stone tops, thickness 2 cm.

Finish

Etna lava stone hand decorated using traditional techniques.
Marble stones and granites as per our samples.

DIMENSIONS

76 cm x 100 cm x 31 cm [Top 65 cm x 100 cm]
111 cm x 100 cm x 31 cm [Top 100 cm x 100 cm]
141 cm x 100 cm x 31 cm [Top 130 cm x 100 cm]

Struttura

Acciaio brunito nero a mano secondo le tecniche tradizionali.
Piani in pietra spessore 2 cm.

Finitura

Pietra lavica dell'Etna decorata a mano secondo le tecniche tradizionali e artigianali. Marmi e graniti nei colori e nelle finiture a campionario.

DIMENSIONI

76 cm x 100 cm x 31 cm [Piano 65 cm x 100 cm]
111 cm x 100 cm x 31 cm [Piano 100 cm x 100 cm]
141 cm x 100 cm x 31 cm [Piano 130 cm x 100 cm]

OR-Table

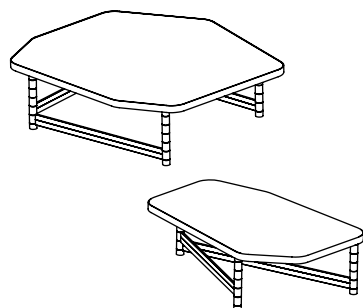

Structure

4 cm diameter brass tube with top belt in brass, h 4 cm, thick 0,4 cm

Finish

Hand-black burnished brass using traditional techniques

Wooden top in shaped solidwood - 2 cm thick

Finish

Heat treated woods as our samples and Swamp Oak oil finish based on natural wax and water.

Stone top thickness 2 cm.

Marble stones and granites as per our samples.

Carbon coated 120 x 80 cm - thick 2,5 cm.

DIMENSIONS

130 cm x 120 cm x 36 cm h

120 cm x 80 cm x 36 cm h

Struttura

Tubolare in ottone diametro 4 cm con fascia top in ottone h. 4 cm, sp. 0,4 cm

Finitura

Ottone brunito nero a mano secondo le tecniche tradizionali.

Piani in legno listellare sagomati - sp. 2 cm

Finitura

Legni termotrattati nelle finiture a campionario e rovere di palude, finiti ad olio a base di cera naturale e acqua.

Piani in pietra sp. 2 cm

Marmi e graniti nei colori e nelle finiture a campionario.

Piani in carbonio 120 x 80 cm - sp. 2,5 cm

DIMENSIONI

130 cm x 120 cm x 36 cm h

120 cm x 80 cm x 36 cm h

Table . Tavolo 120 x 80 x 36 H

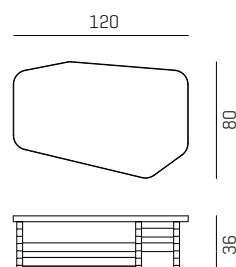
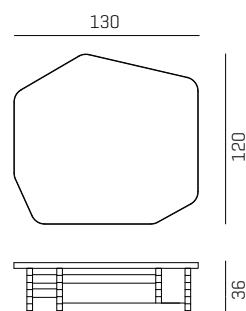

Table . Tavolo 130 x 120 x 36 H



Wood top . Piano in essenza

Oak Thermowood Rovere termizzato	TABLE.OR01	4.062
Eucalyptus Thermowood Eucalipto termizzato		
Acacia Thermowood Acacia termizzato		
Black Eucalyptus Thermowood Eucalipto nero termizzato		
Swamp oak Rovere di palude		4.309
Carbon Carbonio		6.468

Stone top . Piano in Pietra

Cappuccino sanded Cappuccino sabbato	TABLE.OR01	5.673
Renoir Glossy Renoir lucido		
Egeo polished Egeo lucido		
Egeo textured brushed Egeo spazzolato		
Black Fantasy brushed Black Fantasy spazzolato		

Surcharge for burnished brass 3%
Maggiorazione per finitura ottone brunito 3%

Wood top . Piano in essenza

Oak Thermowood Rovere termizzato	TABLE.OR02	4.815
Eucalyptus Thermowood Eucalipto termizzato		
Acacia Thermowood Acacia termizzato		
Black Eucalyptus Thermowood Eucalipto nero termizzato		
Swamp oak Rovere di palude		5.305

Stone top . Piano in Pietra

Cappuccino sanded Cappuccino sabbato	TABLE.OR03	8.086
Renoir Glossy Renoir lucido		
Egeo polished Egeo lucido		
Egeo textured brushed Egeo spazzolato		
Black Fantasy brushed Black Fantasy spazzolato		

Surcharge for burnished brass 3%
Maggiorazione per finitura ottone brunito 3%

Pebble Table

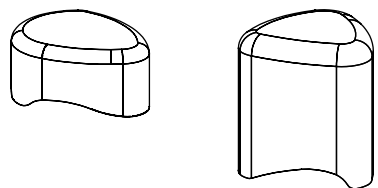

Pebble Table . Tavolo 60 x 60 x 30H

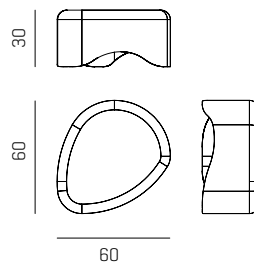

TABLE.PEBB01

2.581

Pebble Table . Tavolo 38 x 38 x 42H

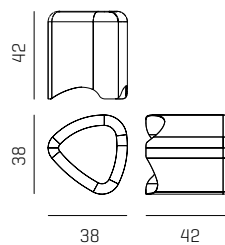

TABLE.PEBB02

1.647

Tables made from stoneware fired at 1250° c.
 Forged by hand, finished by applying natural waxes
 and oxides by hand.
 These are one-off items, because they are both shaped
 and finished by hand.

DIMENSIONS

60 cm x 60 cm x 30 cm h
 38 cm x 38 cm x 42 cm h

Tavoli realizzati in gres cotto a 1250° c.
 La forgiatura viene fatta manualmente e la finitura
 è realizzata attraverso l'applicazioni di ossidi e cere naturali
 mescolate assieme e applicate a mano.
 Questi pezzi sono da considerarsi unici in quanto sia la forma
 che la finitura sono realizzati a mano.

DIMENSIONI

60 cm x 60 cm x 30 cm h
 38 cm x 38 cm x 42 cm h

R-Table

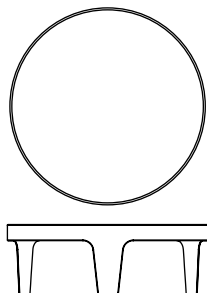

Structure

Curved, shaped wood, thickness 3 cm.

Finish

Heat treated woods as our samples and Swamp Oak oil finish based on natural wax and water.

Top Ø 60 cm - Finish

Hand-turned and hand-burnished brass using traditional techniques. Marble stones and granites as per our samples. Solidwood covered in leather with finishes from the samples available, thickness 2 cm.

Top Ø 82 cm - Finish

Brass with finish hand-burnished using traditional techniques, Marble stones and granites as per our samples. Solidwood covered in leather with finishes from the samples available, thickness 2 cm.

DIMENSIONS

60 cm Ø x 30 cm

82 cm Ø x 35 cm

Struttura

Legno curvato sagomato spessore 3 cm.

Finitura

Legni termotrattati nelle finiture a campionario e rovere di palude, finiti ad olio a base di cera naturale e acqua.

Piano Ø 60 cm - Finitura

Ottone tornito in lastra e brunito a mano secondo le tecniche tradizionali, spessore 2 cm. Marmi e graniti nei colori e nelle finiture a campionario. Legno listellare rivestito in pelle nelle finiture a campionario, spessore 2 cm.

Piano Ø 82 cm - Finitura

Ottone con finitura brunita a mano secondo le tecniche tradizionali. Marmi e graniti nei colori e nelle finiture a campionario. Legno listellare rivestito in pelle nelle finiture a campionario, spessore 2 cm.

DIMENSIONI

60 cm Ø x 30 cm

82 cm Ø x 35 cm

Table . Tavolo 60

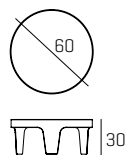

Finishes . Finitura	Code Codice	Burnished Brass Ottone brunito	Top Gray Stone	Egeo, Renoir, Black Fantasy, Meteorus, Cappuccino
---------------------	-------------	--------------------------------	----------------	---

Wood species . Essenze

Wood species . Essenze	Code Codice	Burnished Brass Ottone brunito	Top Gray Stone	Leather . Pelle Cat. 300	Leather . Pelle Cat. 400
Oak Thermowood Rovere termizzato	TABLE. ROUND60	1.640	2.344	1.575	1.589
Eucalyptus Thermowood Eucalpto termizzato					
Black Eucalyptus Thermowood Eucalpto nero termizzato					
Acacia Thermowood Acacia termizzato					
Swamp oak Rovere di palude	1.824	2.528	1.758	1.773	3.039

Finishes . Finitura	Code . Codice	Leather . Pelle Cat. 300	Leather . Pelle Cat. 400
---------------------	---------------	--------------------------	--------------------------

Wood species . Essenze

Wood species . Essenze	Code Codice	Burnished Brass Ottone brunito	Gray Stone	Leather . Pelle Cat. 300	Leather . Pelle Cat. 400
Oak Thermowood Rovere termizzato	TABLE.ROUND60	1.837*	2.875	1.575	1.589
Eucalyptus Thermowood Eucalpto termizzato					
Black Eucalyptus Thermowood Eucalpto nero termizzato					
Acacia Thermowood Acacia termizzato					
Swamp oak Rovere di palude	1.758	1.773	1.758	1.773	1.773

Finishes . Finitura	Code Codice	Burnished Brass Ottone brunito	Gray Stone	Egeo, Renoir, Black Fantasy, Meteorus, Cappuccino
---------------------	-------------	--------------------------------	------------	---

Wood species . Essenze

Wood species . Essenze	Code Codice	Burnished Brass Ottone brunito	Gray Stone	Leather . Pelle Cat. 300	Leather . Pelle Cat. 400
Oak Thermowood Rovere termizzato	TABLE. ROUND80	1.837*	2.875	1.575	1.589
Eucalyptus Thermowood Eucalpto termizzato					
Black Eucalyptus Thermowood Eucalpto nero termizzato					
Acacia Thermowood Acacia termizzato					
Swamp oak Rovere di palude	2.090*	3.129	1.758	1.773	3.644

Finishes . Finitura	Code . Codice	Leather . Pelle Cat. 300	Leather . Pelle Cat. 400
---------------------	---------------	--------------------------	--------------------------

Wood species . Essenze

Wood species . Essenze	Code Codice	Burnished Brass Ottone brunito	Gray Stone	Leather . Pelle Cat. 300	Leather . Pelle Cat. 400
Oak Thermowood Rovere termizzato	TABLE.ROUND80	1.837*	2.875	1.575	1.589
Eucalyptus Thermowood Eucalpto termizzato					
Black Eucalyptus Thermowood Eucalpto nero termizzato					
Acacia Thermowood Acacia termizzato					
Swamp oak Rovere di palude	2.249	3.129	1.758	1.773	2.279

* Brass Ø 80 occasional table available only with straight, non calendered top.

* Tavolino Ø 80 in ottone disponibile solo con piano dritto, non calandrato.

Poke Table

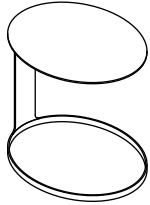
**Structure**

Bent sheet, thickness 8 cm.

Top

Bent sheet, thickness 3 cm

Finish

Steel hand-burnished black using traditional techniques.

DIMENSIONS

55 cm x 44 cm x 52 cm h

Poke Table . Tavolo 55 x 44 x 52H

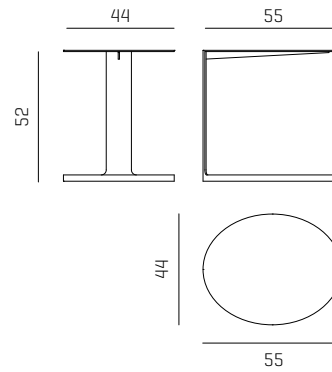

TABLE.POKE01

924

Struttura

Lamiera sp. 8 cm piegata

Piano

Lamiera sp. 3 cm

Finitura

Acciaio brunito nero a mano secondo le tecniche tradizionali.

DIMENSIONI

55 cm x 44 cm x 52 cm h

W-Table

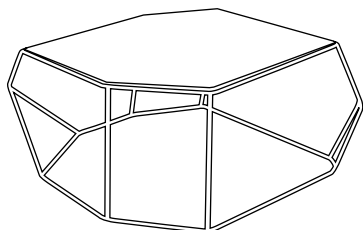

Structure

Ø 1 cm rod

Finish

Black steel hand-burnished using traditional techniques.

Brass hand-burnished using traditional techniques.

Wood tops

Solidwood topshaped, thickness 2 cm.

Finish

Heat treated woods as our samples and Swamp Oak

oil finish based on natural wax and water.

Covered in leather from the samples available.

Stone top

Stone top, thickness 2 cm.

Finish

Marble stones and granites as per our samples.

DIMENSIONS

61 cm x 58 cm x 30 cm

45 cm x 45 cm x 40 cm

37 cm x 35 cm x 50 cm

W-table h. 30

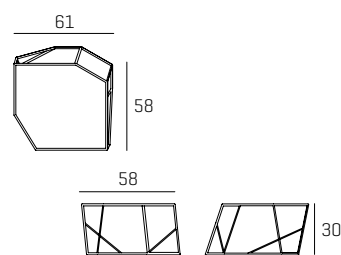

Wood top . Piano in essenza

Oak Thermowood Rovere termizzato	TABLE.WIRE30	961	1.292
Eucalyptus Thermowood Eucalipto termizzato			
Black Eucalyptus Thermowood Eucalipto nero termizzato			
Acacia Thermowood Acacia termizzato		1.084	1.417
Swamp oak Rovere di palude			

Leather top . Piano in pelle

Leather . Pelle cat. 300	TABLE.WIRE30	1.178	1.426
Leather . Pelle cat. 400			

Stone top . Piano in Pietra

Gray Stone smooth Gray Stone levigato	TABLE.WIRE30	1.365	1.696
Cappuccino sanded Cappuccino sabbaiato		1.530	1.862
Meteorus Egeo Black fantasy Renoir			

W-table h. 40

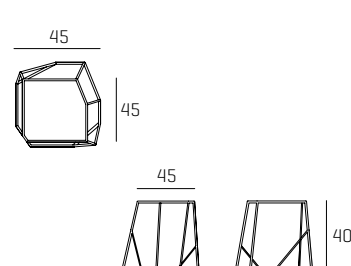

Wood top . Piano in essenza

Oak Thermowood Rovere termizzato	TABLE.WIRE40	805	1.136
Eucalyptus Thermowood Eucalipto termizzato			
Black Eucalyptus Thermowood Eucalipto nero termizzato			
Acacia Thermowood Acacia termizzato		858	1.189
Swamp oak Rovere di palude			

Leather top . Piano in pelle

Leather . Pelle cat. 300	TABLE.WIRE40	857	1.188
Leather . Pelle cat. 400			

Stone top . Piano in Pietra

Gray Stone smooth Gray Stone levigato	TABLE.WIRE40	1.056	1.386
Cappuccino sanded Cappuccino sabbaiato		1.116	1.447
Meteorus Egeo Black fantasy Renoir			

W-Table

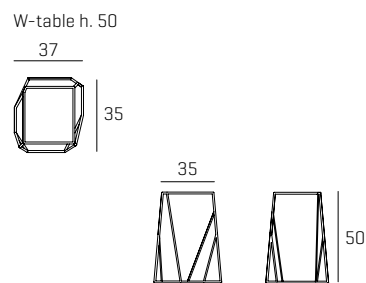

Struttura

Tondino Ø 1 cm

Finitura

Acciaio brunito nero a mano secondo le tecniche tradizionali.

Ottone brunito a mano secondo le tecniche tradizionali.

Piano in legno

Legno listellare sagomato spessore 2 cm.

Finitura

Legni termotrattati nelle finiture a campionario e rovere

di palude, finiti ad olio a base di cera naturale e acqua.

Rivestito nelle pelle a campionario.

Piano in pietra

Pietra spessore 2 cm.

Finitura

Marmi e graniti nei colori e nelle finiture a campionario.

DIMENSIONI

61 cm x 58 cm x 30 cm

45 cm x 45 cm x 40 cm

37 cm x 35 cm x 50 cm

Wood top . Piano in essenza

Oak Thermowood Rovere termizzato	TABLE.WIRE50	805	1.136
Eucalyptus Thermowood Eucalipto termizzato			
Black Eucalyptus Thermowood Eucalipto nero termizzato	TABLE.WIRE50	840	1.170
Acacia Thermowood Acacia termizzato			
Swamp oak Rovere di palude			

Leather top . Piano in pelle

Leather . Pelle cat. 300 Leather . Pelle cat. 400	TABLE.WIRE50	848	1.095
--	--------------	-----	-------

Stone top . Piano in Pietra

Gray Stone smooth Gray Stone levigato	TABLE.WIRE50	1.040	1.369
Cappuccino sanded Cappuccino sabbiato			
Meteorus Egeo Black fantasy Renoir	TABLE.WIRE50	1.082	1.412

Edge Mirror

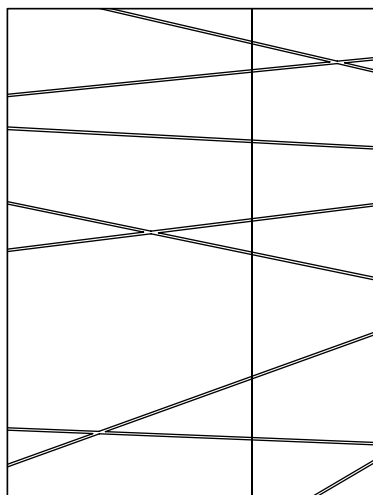

Frame

Solidwood, thickness 2,5 cm.

Finish

Heat treated woods as our samples and Swamp Oak oil finish based on natural wax and water.

Mirror with silver finish, thickness 0,6 cm, polished thread with burnished brass inlays.

DIMENSIONS

200 cm x 50 cm x 13 cm
200 cm x 75 cm x 13 cm
200 cm x 100 cm x 13 cm

Struttura

Legno listellare spessore 2,5 cm.

Finitura

Legni termotrattati nelle finiture a campionario e rovere di palude, finiti ad olio a base di cera naturale e acqua.

Specchio argentato spessore 0,6 cm filo lucido con intarsi in ottone brunito.

DIMENSIONI

200 cm x 50 cm x 13 cm
200 cm x 75 cm x 13 cm
200 cm x 100 cm x 13 cm

Mirror . Specchio 50

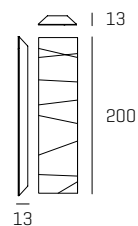

EDGE.MIR01

2.135

Mirror . Specchio 75

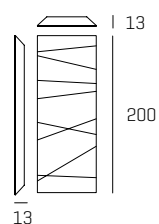

EDGE.MIR02

2.807

Mirror . Specchio 100

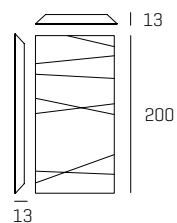

EDGE.MIR03

3.414

Suggested composition
Composizioni suggerite

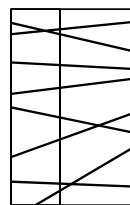

2 mirrors . 2 specchi
[50+75]

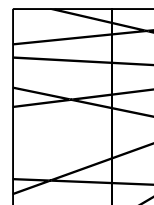

2 mirrors . 2 specchi
[100+50]

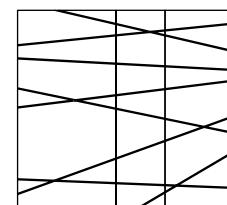

3 mirrors . 3 specchi
[100+50+75]

H-Vases



Large cone vase . Vaso cono grande Ø24,5/H cm 30

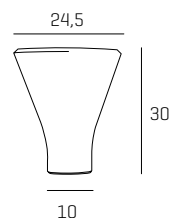

VASES.H A

646

Small cone vase . Vaso cono piccolo Ø18/H cm 25

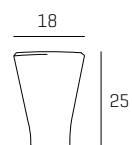

VASES.H B

537

Smalle spool vase . Vaso rocchetto piccolo Ø16/H cm 25

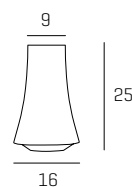

VASES.H C

538

Long spool vase . Vaso rocchetto alto Ø13/H cm 30

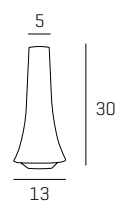

VASES.H D

390

Medium bowl . Ciotola media Ø42/H cm 10

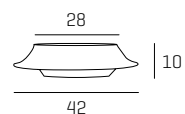

VASES.H E

893

Low bowl . Ciotola bassa Ø42/H cm 5,5

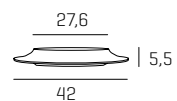

VASES.H F

830

Long bowl . Ciotola alta Ø42/H cm 25

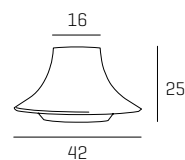

VASES.H G

995

Vases made of porcelain stoneware fired at 1250 °C. Each one is individually hand-turned and the finish is made applying oxide and natural wax which are mixed and manually applied. Every piece and its finish is different, a one-of-a-kind work of art because they are all made entirely by hand.

Vasi realizzati in grès cotto a 1250 °C. La foggatura viene fatta manualmente al tornio e la finitura della superficie è realizzata attraverso l'applicazione di ossidi e cere naturali mescolate assieme e applicate a mano.

Questi pezzi sono da considerarsi unici, in quanto la forma, essendo realizzata a mano, ed anche la finitura della superficie sono diverse.

Black Widow

Black Widow

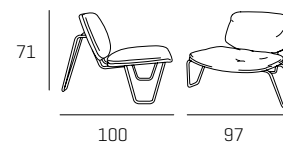

Burnished steel
Acciaio brunito

COUCH
BLACKWI

3.226

3.364

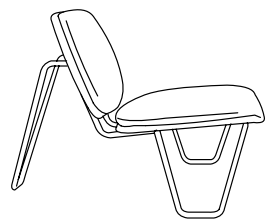

Occasional chair with Ø 2,2 cm heavy duty curved metal pipe frame.

Finish

Black steel hand-burnished using traditional techniques.

Padded seat with finish in leather from the samples in the range.

DIMENSIONS

97 cm x 100 cm x 71 cm

H seat: 38 cm

Poltroncina con struttura in tubo metallico ad alta resistenza di Ø 2,2 cm curvato.

Finitura

Acciaio brunito nero a mano secondo le tecniche tradizionali.

Seduta imbottita con finitura in pelle nella gamma a campionario.

DIMENSIONI

97 cm x 100 cm x 71 cm

H seduta: 38 cm

Eighty Armchair

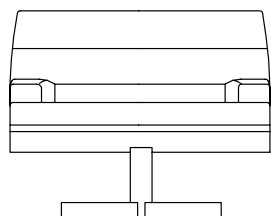

Eighty Armchair . Poltrona fissa

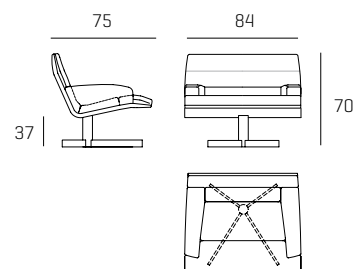

 Burnished steel
Acciaio brunito

COUCH.EIGH01

3.801

4.059

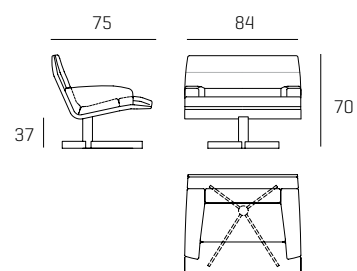
Eighty Swivel Armchair . Poltrona girevole

 Burnished steel
Acciaio brunito

COUCH.EIGH02

3.855

4.113

Club chair with curved metal pipe frame and steel base

Finish

Base in steel burnished black by hand using traditional techniques. Padded seat, back and arms with leather in leather finish from the samples in the range

DIMENSIONS

84 cm x 75 cm x 70 cm

H seat: 37 cm

Poltroncina con struttura in curvato e basamento in acciaio

Finitura

Basamento in Acciaio brunito nero a mano secondo le tecniche tradizionali. Seduta, schienale e braccioli imbottiti con finitura in pelle nella gamma a campionario.

DIMENSIONI

84 cm x 75 cm x 70 cm

H seduta: 37 cm

Is-A Chair

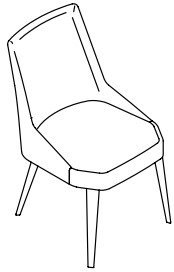

Is-A Chair

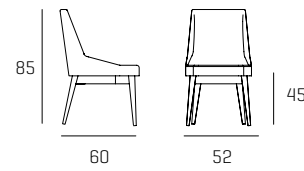

CHAIR.IS-A	1.066	1.350	1.458
------------	-------	-------	-------

Dinning chair with beech wood.
Seat covered with leather or fabric from our range.

Base finish

Varnished Black Eucalyptus

DIMENSIONS

85 cm x 60 cm x 52 cm

H seat: 45 cm

Sedia con basamento in legno di faggio e seduta rivestita in pelle o tessuto nella gamma dei colori a campionario.

Finitura Basamento

Verniciato Eucalipto Nero.

DIMENSIONI

85 cm x 60 cm x 52 cm

H seduta: 45 cm

June Chair

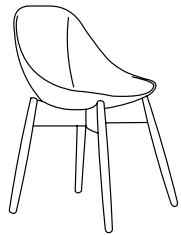

June Chair

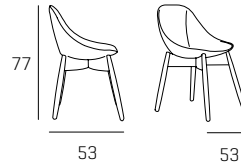

Varnished Black Eucalyptus Eucalipto nero verniciato	CHAIR.JUNE	1.014	1.083
Varnished Oak Rovere verniciato			

Dining chair with beech wood base and polyurethane seat.
Cover in leather from our range.

Base finish

Varnished Black Eucalyptus, varnished Oak.

DIMENSIONS

53 cm x 53 cm x 77 cm

H seat: 45 cm

Sedia con basamento in Legno di faggio e seduta in poliuretano,
Rivestito nella gamma delle pelli a campionario

Finitura Basamento

Verniciato Eucalipto Nero, verniciato Rovere.

DIMENSIONI

53 cm x 53 cm x 77 cm

H seduta: 45 cm

Hexagon Chair

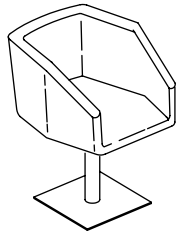

Hexagon Fix Chair - Fissa

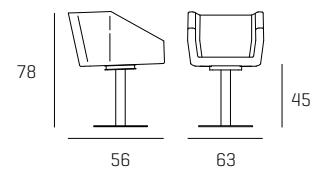

CHAIR.HEX01	907	1.220	1.328
-------------	-----	-------	-------

Hexagon Swivel Chair . Girevole

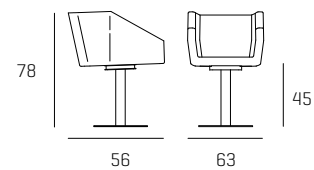

CHAIR.HEX02	961	1.274	1.382
-------------	-----	-------	-------

Chair with base in steel, padded seat covered with leather or fabric from our range.

Base finish

Steel finish hand burnished brass using traditional techniques.

DIMENSIONS

56 cm x 63 cm x 78 cm

H seat: 45 cm

Sedia con basamento in acciaio, seduta imbottita e rivestita in pelle o tessuto nella gamma dei colori a campionario

Finitura Basamento

Acciaio brunito finitura ottone, brunito a mano secondo le tecniche tradizionali.

DIMENSIONI

56 cm x 63 cm x 78 cm

H seduta: 45 cm

Rio Stool

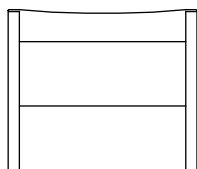

Rio stool . Sgabello

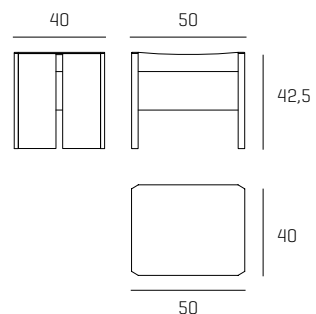

Wood . Essenze

Oak Thermowood Rovere termizzato Eucalyptus Thermowood Eucalipto termizzato Black Eucalyptus Thermowood Eucalipto nero termizzato Acacia Thermowood Acacia termizzato	CHAIR.R1001	781
Swamp oak Rovere di palude		895

Structure

Solidwood, thickness 3,6 cm, with central crosspiece covered in brass hand-burnished using traditional techniques; seat in Durango leather with finishes from the samples available

Finish

Heat treated woods as our samples and Swamp Oak oil finish based on natural wax and water.

DIMENSIONS

50 cm x 40 cm x 42.5 cm

Struttura

Legno listellare spessore 3,6 cm con traverso centrale rivestito in ottone brunito a mano secondo le tecniche tradizionali.

Seduta in pelle Durango nelle finiture a campionario

Finitura

Legni termotrattati nelle finiture a campione e rovere di palude finiti ad olio a base di cera naturale e acqua.

DIMENSIONI

50 cm x 40 cm x 42.5 cm

Strip Chair

Strip Chair

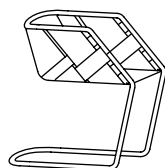
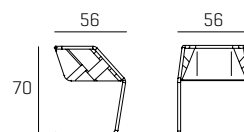

Painted Dove grey Verniciato Tortora	CHAIR.STRIPE	1.339
Painted Minio Verniciato Minio		
Burnished Steel Acciaio brunito		1.511
Burnished Brass Ottone brunito		1.813

Surcharge for black burnished brass 3%
Maggiorazione per finitura ottone brunito nero 3%

Dining chair with Ø 2,5 cm heavy duty curved metal pipe frame.

Finish

Brick red or dove grey paint finish. Black steel hand-burnished using traditional techniques. Brass hand-burnished using traditional techniques. Seat padded with woven laser cut double thickness leather Durango or Nabuk.

DIMENSIONS

56 cm x 56 cm x 70 cm.

H seat: 45 cm

Poltroncina uso pranzo con struttura in tubo metallico ad alta resistenza di Ø 2,5 cm curvato.

Finitura

Verniciato nei colori rosso minio o tortora. Acciaio brunito a mano secondo le tecniche tradizionali. Ottone brunito a mano secondo le tecniche tradizionali. Seduta imbottita con finitura in pelle Durango o Nabuk intrecciata e lavorata al laser a doppio spessore.

DIMENSIONI

56 cm x 56 cm x 70 cm

H seduta: 45 cm

ES - Table



Tavolo . Table 250x98x75h

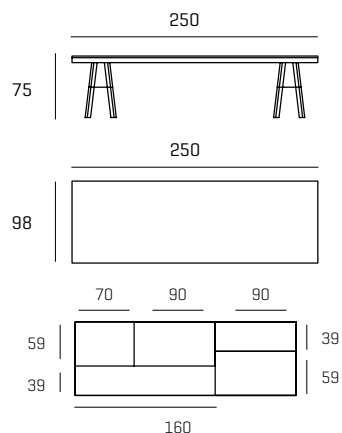

Code . Codice	Combinazione Finitura .Combinazione Finitura		Price . Prezzo
	Legs . gambe	Top . Piano	

TABLE.ES01

Burnished brass/ Thermowood Ottone brunito / Legni termizzati	Thermowood Legni termizzati	5.540
Burnished brass/ Swamp Oak Ottone brunito / Rovere di Palude	Swamp Oak Rovere di Palude	6.531
Burnished brass/ Thermowood Ottone brunito / Legni termizzati	Burnished brass Ottone brunito	7.314

Surcharge for black burnished brass 5%
Maggiorazione per finitura ottone brunito nero 5%

Tavolo . Table 300x98x75h

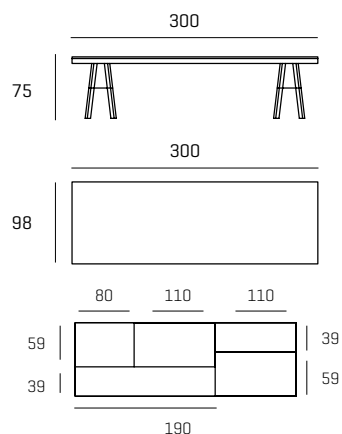

TABLE.ES02

Burnished brass/ Thermowood Ottone brunito / Legni termizzati	Thermowood Legni termizzati	5.944
Burnished brass/ Swamp Oak Ottone brunito / Rovere di Palude	Swamp Oak Rovere di Palude	7.077
Burnished brass/ Thermowood Ottone brunito / Legni termizzati	Burnished brass Ottone brunito	7.773

Surcharge for black burnished brass 5%
Maggiorazione per finitura ottone brunito nero 5%

Structure

Solidwood, thickness 20 mm with cover for legs in burnished brass with laser-cut pattern

Top finish

Heat treated woods as our samples and Swamp Oak oil finish based on natural wax and water.

Slabs in brass hand-burnished using traditional techniques.

Legs finish

Heat treated woods as our samples and Swamp Oak oil finish based on natural wax and water.

Cover in brass hand-burnished using traditional techniques.

DIMENSIONS

300 cm x 98 cm x 75 cm

Struttura

Legno listellare sp. 2 cm con carter per gambe in ottone con disegno fantasia taglio laser

Finitura Piano

Legni termotrattati nelle finiture a campionario e rovere di palude, finiti ad olio a base di cera naturale e acqua.

Lastre in ottone brunito a mano secondo le tecniche tradizionali.

Finitura gambe

Legni termotrattati nelle finiture a campionario e rovere di palude, finiti ad olio a base di cera naturale e acqua.

Carter in ottone brunito a mano secondo le tecniche tradizionali.

DIMENSIONI

300 cm x 98 cm x 75 cm

K-Table 2 boards . 2 assi

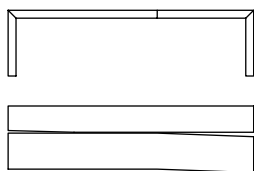

Frame

Solidwood, thickness 8 cm handcrafted on a 45 degree angle.

Finish

Heat treated woods as our samples and Swamp Oak oil finish based on natural wax and water.

DIMENSIONS

79 cm x 240 cm x 75 cm

79 cm x 280 cm x 75 cm

Struttura

Legno listellare spessore 8 cm lavorato a mano con taglio 45°.

Finitura

Legni termotrattati nelle finiture a campionario e rovere di palude, finiti ad olio a base di cera naturale e acqua.

DIMENSIONI

79 cm x 240 cm x 75 cm

79 cm x 280 cm x 75 cm

K-Table 3 boards . 3 assi

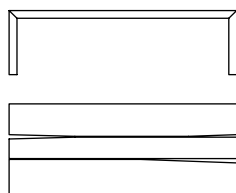

Dining table.

Frame

Solidwood, thickness 8 cm handcrafted on a 45 degree angle.

Finish

Heat treated woods as our samples and Swamp Oak oil finish based on natural wax and water.

DIMENSIONS

105 cm x 260 cm x 75 cm

105 cm x 320 cm x 75 cm

Tavolo uso pranzo.

Struttura

Legno listellare spessore 8 cm lavorato a mano con taglio 45°.

Finitura

Legni termotrattati nelle finiture a campionario e rovere di palude, finiti ad olio a base di cera naturale e acqua.

DIMENSIONI

105 cm x 260 cm x 75 cm

105 cm x 320 cm x 75 cm

Finishes . Finitura	Code . Codice	Price . Prezzo
---------------------	---------------	----------------

K-Table 240

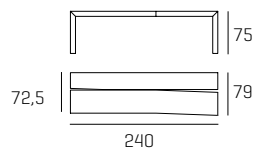

Wood species . Essenze

Oak Thermowood Rovere termizzato	TABLE.K-2A240	8.281
Eucalyptus Thermowood Eucalipto termizzato		
Black Eucalyptus Thermowood Eucalipto termizzato nero		
Acacia Thermowood Acacia termizzato		
Swamp oak Rovere di palude		9.868

K-Table 280

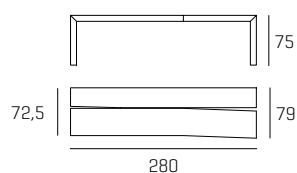

Wood species . Essenze

Oak Thermowood Rovere termizzato	TABLE.K-2A280	8.411
Eucalyptus Thermowood Eucalipto termizzato		
Black Eucalyptus Thermowood Eucalipto termizzato nero		
Acacia Thermowood Acacia termizzato		
Swamp oak Rovere di palude		10.156

Finishes . Finitura	Code . Codice	Price . Prezzo
---------------------	---------------	----------------

K-Table 260

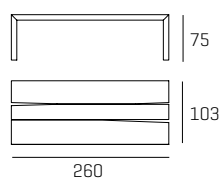

Wood species . Essenze

Oak Thermowood Rovere termizzato	TABLE.K-3A240	10.002
Eucalyptus Thermowood Eucalipto termizzato		
Black Eucalyptus Thermowood Eucalipto termizzato nero		
Acacia Thermowood Acacia termizzato		
Swamp oak Rovere di palude		11.223

K-Table 320

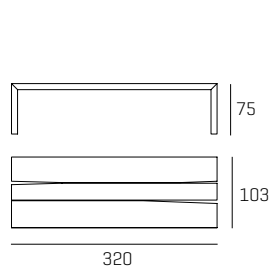

Wood species . Essenze

Oak Thermowood Rovere termizzato	TABLE.K-3A320	10.258
Eucalyptus Thermowood Eucalipto termizzato		
Black Eucalyptus Thermowood Eucalipto termizzato nero		
Acacia Thermowood Acacia termizzato		
Swamp oak Rovere di palude		11.289

K-Table 2 boards desk use . 2 assi uso scrivania

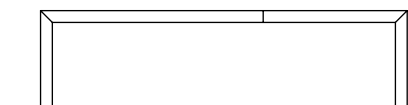

Leather . Pelle

Table for desk use.

Structure

Solidwood, thickness 8 cm handcrafted on a 45 degree angle.

Finish

Heat treated woods as our samples and Swamp Oak

oil finish based on natural wax and water.

Part of the top in leather from our range.

DIMENSIONS

79 cm x 240 cm x 75 cm

79 cm x 280 cm x 75 cm

Drawer K-Table

Structure

2 cm multilayer wood and traditionally hand-burnished brass

Drawer

2 cm multi-layered wood lacquered matt color slate.

Soft-close slides.

DIMENSIONS

80 cm x 48 cm x 50 cm

Tavolo uso scrivania.

Struttura

Legno listellare spessore 8 cm lavorato a mano con taglio 45°.

Finitura

Legni termotrattati nelle finiture a campionario e rovere

di palude, finiti ad olio a base di cera naturale e acqua.

Parte del piano disponibile nella gamma delle pelli a campionario.

DIMENSIONI

79 cm x 240 cm x 75 cm

79 cm x 280 cm x 75 cm

Cassettiera K-Table

Struttura

Legno listellare spessore 2 cm e ottone brunito a mano secondo le tecniche tradizionali.

Cassetto

Sponde legno listellare 2 cm laccato opaco color lavagna.

Guide rallentate.

DIMENSIONI

80 cm x 48 cm x 50 cm

Finishes . Finitura

Code . Codice

Leather . Pelle
Cat. 300

Leather . Pelle
Cat. 400

K Table 240

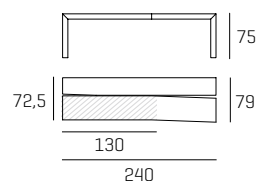

Wood species . Essenze

Oak Thermowood Rovere termizzato	TABLE.K-SC240	9.151	9.295
Eucalyptus Thermowood Eucalipto termizzato			
Black Eucalyptus Thermowood Eucalipto termizzato nero			
Acacia Thermowood Acacia termizzato			
Swamp oak Rovere di palude		10.738	10.875

K Table 280

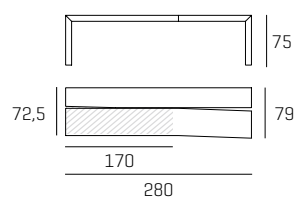

Wood species . Essenze

Oak Thermowood Rovere termizzato	TABLE.K-SC280	9.270	9.407
Eucalyptus Thermowood Eucalipto termizzato			
Black Eucalyptus Thermowood Eucalipto termizzato nero			
Acacia Thermowood Acacia termizzato			
Swamp oak Rovere di palude		11.026	11.163

Finishes . Finitura

Code . Codice

Price . Prezzo

K-Drawer

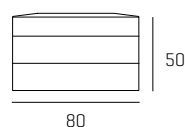

Wood species . Essenze

Oak Thermowood Rovere termizzato		2.734
Eucalyptus Thermowood Eucalipto termizzato		
Black Eucalyptus Thermowood Eucalipto termizzato nero		
Acacia Thermowood Acacia termizzato		
Swamp oak Rovere di palude		2.979

Burnished brass
Ottone brunito

TABLE.K-CA001

4.633

Surcharge for black burnished brass 5%

Maggiorazione per finitura ottone brunito nero 5%

K-Table 1 board . 1 asse



Console table and sofa back console.

Frame

Solidwood, thickness 8 cm handcrafted on a 45 degree angle.

Finish

Heat treated woods as our samples and Swamp Oak oil finish based on natural wax and water.

DIMENSIONS

38 cm x 220 cm x 60 cm
 38 cm x 200 cm x 60 cm
 38 cm x 220 cm x 80 cm
 38 cm x 200 cm x 80 cm

Tavolo uso consolle e retrodivano.

Struttura

Legno listellare spessore 8 cm lavorato a mano con taglio 45°.

Finitura

Legni termotrattati nelle finiture a campionario e rovere di palude, finiti ad olio a base di cera naturale e acqua.

DIMENSIONI

38 cm x 220 cm x 60 cm
 38 cm x 200 cm x 60 cm
 38 cm x 220 cm x 80 cm
 38 cm x 200 cm x 80 cm

K-TABLE SOFA BACK H.60 K-TABLE RETRODIVANO H.60

K-Table 200

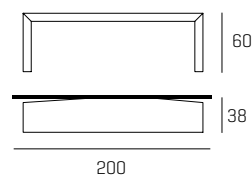

Wood species . Essenze

Oak Thermowood Rovere termizzato	TABLE.K-RE200	4.232
Eucalyptus Thermowood Eucalipto termizzato		
Black Eucalyptus Thermowood Eucalipto termizzato nero		
Acacia Thermowood Acacia termizzato		
Swamp oak Rovere di palude		4.808

K-Table 220

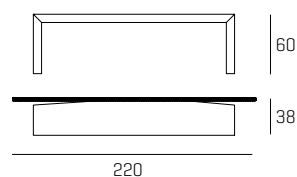

Wood species . Essenze

Oak Thermowood Rovere termizzato	TABLE.K-RE220	4.446
Eucalyptus Thermowood Eucalipto termizzato		
Black Eucalyptus Thermowood Eucalipto termizzato nero		
Acacia Thermowood Acacia termizzato		
Swamp oak Rovere di palude		5.069

K-TABLE CONSOLLE H.80

K-Table 200

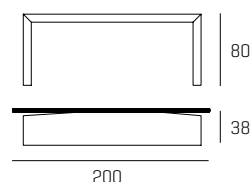

Wood species . Essenze

Oak Thermowood Rovere termizzato	TABLE.K-CO200	4.242
Eucalyptus Thermowood Eucalipto termizzato		
Black Eucalyptus Thermowood Eucalipto termizzato nero		
Acacia Thermowood Acacia termizzato		
Swamp oak Rovere di palude		4.882

K-Table 220

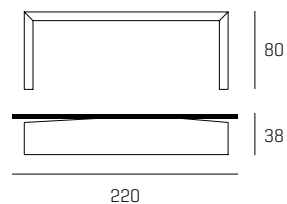

Wood species . Essenze

Oak Thermowood Rovere termizzato	TABLE.K-CO220	4.461
Eucalyptus Thermowood Eucalipto termizzato		
Black Eucalyptus Thermowood Eucalipto termizzato nero		
Acacia Thermowood Acacia termizzato		
Swamp oak Rovere di palude		5.162

LY-Table Wood . Legno

LY-Table 260 x 110

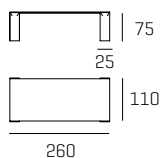

LY-Table 320 x 110

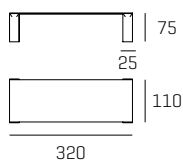

64

Frame

In metal and solid wood with shaped legs and sides.

Finish

Heat treated woods as our samples and Swamp Oak oil finish based on natural wax and water.

Top

In solidwood, thickness 2 cm, edge profile shaped

Finish

Heat treated woods as our samples and Swamp Oak oil finish based on natural wax and water.

DIMENSIONS

260 cm x 110 cm x 75 cm

320 cm x 110 cm x 75 cm

Struttura

Metallo e legno massello con sagomatura di gambe e struttura.

Finitura

Legni termotrattati nelle finiture a campionario e rovere di palude, finiti ad olio a base di cera naturale e acqua.

Piano

In legno listellare spessore 2 cm profilo perimetrale sagomato.

Finitura

Legni termotrattati nelle finiture a campionario e rovere di palude, finiti ad olio a base di cera naturale e acqua.

DIMENSIONI

260 cm x 110 cm x 75 cm

320 cm x 110 cm x 75 cm

Code . Codice	Finishes combination . Combinazioni di finitura		Price . Prezzo
	Legs . Gambe	Top . Piano	

TABLE.LY002	Oak Thermowood Rovere termizzato	Oak Thermowood Rovere termizzato	6.495
	Eucalyptus Thermowood Eucalipto termizzato	Eucalyptus Thermowood Eucalipto termizzato	
	Black Eucalyptus Thermowood Eucalipto termizzato nero	Black Eucalyptus Thermowood Eucalipto termizzato nero	
	Acacia Thermowood Acacia termizzato	Acacia Thermowood Acacia termizzato	
	Swamp oak Rovere di palude	Swamp oak Rovere di palude	7.761

TABLE.LY003	Oak Thermowood Rovere termizzato	Oak Thermowood Rovere termizzato	7.426
	Eucalyptus Thermowood Eucalipto termizzato	Eucalyptus Thermowood Eucalipto termizzato	
	Black Eucalyptus Thermowood Eucalipto termizzato nero	Black Eucalyptus Thermowood Eucalipto termizzato nero	
	Acacia Thermowood Acacia termizzato	Acacia Thermowood Acacia termizzato	
	Swamp oak Rovere di palude	Swamp oak Rovere di palude	9.753

LY-Table Wood - Metal Mesh . Legno - Rete metallica



Frame

In metal and solid wood with shaped legs and sides.

External finish

Heat treated woods as our samples and Swamp Oak oil finish based on natural wax and water.

Internal finish

Burnished steel mesh tweed pattern.

Top

In solidwood, thickness 2 cm, edge profile shaped.

Finish

Heat treated woods as our samples and Swamp Oak oil finish based on natural wax and water.

DIMENSIONS

260 cm x 110 cm x 75 cm

320 cm x 110 cm x 75 cm

Struttura

Metallo e legno massello con sagomatura di gambe e struttura.

Finitura Esterna

Legni termotrattati nelle finiture a campionario e rovere di palude, finiti ad olio a base di cera naturale e acqua.

Finitura Interna

Maglia d'acciaio tweed brunita.

Piano

In legno listellare spessore 2 cm profilo perimetrale sagomato.

Finitura

Legni termotrattati nelle finiture a campionario e rovere di palude, finiti ad olio a base di cera naturale e acqua.

DIMENSIONI

260 cm x 110 cm x 75 cm

320 cm x 110 cm x 75 cm

Code . Codice	Finishes combination . Combinazioni di finitura			Price . Prezzo
	Legs inner Interno gambe	Legs outer Esterno gambe	Top . Piano	

LY-Table 260 x 110

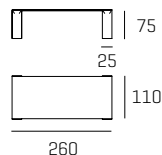

TABLE.LY005	Tweed burnished steel mesh Maglia d'acciaio Tweed brunita	Oak Thermowood Rovere termizzato Eucalyptus Thermowood Eucalipto termizzato Black Eucalyptus Thermowood Eucalipto termizzato nero Acacia Thermowood Acacia termizzato	Oak Thermowood Rovere termizzato Eucalyptus Thermowood Eucalipto termizzato Black Eucalyptus Thermowood Eucalipto termizzato nero Acacia Thermowood Acacia termizzato	9.669
	Tweed burnished steel mesh Maglia d'acciaio Tweed brunita	Swamp oak Rovere di palude	Swamp oak Rovere di palude	11.402

LY-Table 320 x 110

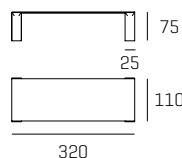
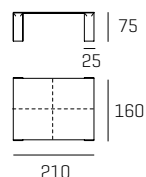

TABLE.LY006	Tweed burnished steel mesh Maglia d'acciaio Tweed brunita	Oak Thermowood Rovere termizzato Eucalyptus Thermowood Eucalipto termizzato Black Eucalyptus Thermowood Eucalipto termizzato nero Acacia Thermowood Acacia termizzato	Oak Thermowood Rovere termizzato Eucalyptus Thermowood Eucalipto termizzato Black Eucalyptus Thermowood Eucalipto termizzato nero Acacia Thermowood Acacia termizzato	10.754
	Tweed burnished steel mesh Maglia d'acciaio Tweed brunita	Swamp oak Rovere di palude	Swamp oak Rovere di palude	12.661

LY-Table Stone - Wood . Pietra - Legno



LY-Table 210x160



LY-Table 260x110 *

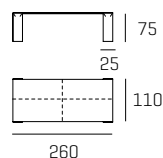

LY-Table 320x110

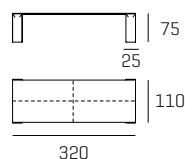

Frame

In metal, solid wood and stone with shaped legs and sides.

External legs finish

Cappuccino and Egeo

Internal finish

Heat treated woods as our samples and Swamp Oak oil finish based on natural wax and water.

Top

In stone, thickness 2 cm (4 pieces book matched), shaped surround profile .

Finish

Cappuccino and Egeo

DIMENSIONS

210 cm x 160 cm x 75 cm

260 cm x 110 cm x 75 cm

320 cm x 110 cm x 75 cm

Struttura

Metallo, legno massello e pietra con sagomatura di gambe e struttura.

Finitura Esterna gambe

Cappuccino idrosabbato spazzolato e Egeo

Finitura Interna

Legni termotrattati nelle finiture a campionario e rovere di palude, finiti ad olio a base di cera naturale e acqua.

Piano

In pietra spessore 2 cm (4 pz a macchia aperta) profilo perimetrale sagomato.

Finitura

Cappuccino idrosabbato spazzolato e Egeo

DIMENSIONI

210 cm x 160 cm x 75 cm

260 cm x 110 cm x 75 cm

320 cm x 110 cm x 75 cm

Code . Codice	Finishes combination . Combinazioni di finitura			Price . Prezzo
	Legs inner Interno gambe	Legs outer Esterno gambe	Top . Piano	

TABLE.LY007	Oak Thermowood Rovere termizzato	Cappuccino Egeo	Cappuccino Egeo	17.768
	Eucalyptus Thermowood Eucalpto termizzato			
	Black Eucalyptus Thermowood Eucalpto nero termizzato			
	Acacia Thermowood Acacia termizzato			
	Swamp oak Rovere di palude	Cappuccino	Cappuccino	18.374

TABLE.LY008	Oak Thermowood Rovere termizzato	Cappuccino Egeo	Cappuccino Egeo	17.767
	Eucalyptus Thermowood Eucalpto termizzato			
	Black Eucalyptus Thermowood Eucalpto nero termizzato			
	Acacia Thermowood Acacia termizzato			
	Swamp oak Rovere di palude	Cappuccino	Cappuccino	18.374

TABLE.LY009	Oak Thermowood Rovere termizzato	Cappuccino Egeo	Cappuccino Egeo	20.089
	Eucalyptus Thermowood Eucalpto termizzato			
	Black Eucalyptus Thermowood Eucalpto nero termizzato			
	Acacia Thermowood Acacia termizzato			
	Swamp oak Rovere di palude	Cappuccino Egeo	Cappuccino Egeo	20.696

* Any request for monolithical top, has to be assessed by reference to the chosen material and the availability of the slab at the moment of the order confirmation.
Eventuali richieste del top in lastra unica da valutare in riferimento al tipo di materiale e alla disponibilità delle lastre alla conferma dell'ordine.

Penny Table

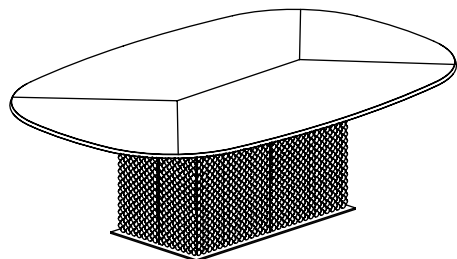
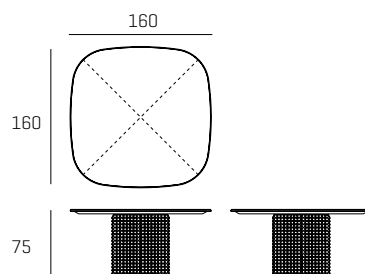

Table . Tavolo 160 x 160 *



Finishes Top
Finitura Top

Code
Codice

Price . Prezzo

Structure . Struttura

Wood species . Essenze

Oak Thermowood Rovere termizzato	TABLE.PENNY1	11.446
Heat treated Eucalyptus Eucalipto termo trattato		
Black Eucalyptus Eucalipto nero		
Acacia Thermowood Acacia termizzato	TABLE.PENNY1	12.368
Swamp oak Rovere di palude		

Cappuccino sanded Cappuccino sabbaiato	TABLE.PENNY1	14.737
Black fantasy brushed Black fantasy spazzolato		
Egeo stone textured glossy Egeo ondulato lucido		
Egeo stone, textured brushed Egeo ondulato spazzolato		

Structure

Internal structure in steel hand-burnished brass glor using traditional techniques. Brass casing, hand-burnished brass using traditional techniques. Undertop in black lacquered 3 cm thick solidwood 2 cm thick stone top

Finish - Top

Marble stones and granites as per our samples.

DIMENSIONS

160 cm x 160 cm x 75 cm h
240 cm x 160 cm x 75 cm h

Struttura

Carter in ottone brunito a mano secondo le tecniche tradizionali con struttura interna in acciaio brunito finitura ottone a mano secondo le tecniche tradizionali, sottotop sp. 3 cm laccato nero opaco.

Piano in pietra sp. 2 cm

Finitura - Piano

Marmi e graniti nei colori e nelle finiture a campionario.

DIMENSIONI

160 cm x 160 cm x 75 cm h
240 cm x 160 cm x 75 cm h

Table . Tavolo 240 x 160 *

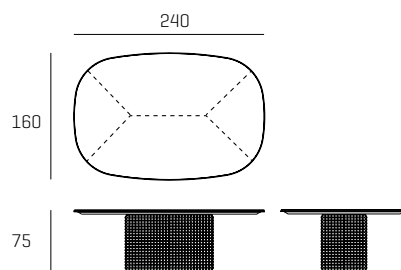

Wood species . Essenze

Oak Thermowood Rovere termizzato	TABLE.PENNY2	12.308
Heat treated Eucalyptus Eucalipto termo trattato		
Black Eucalyptus Eucalipto nero		
Acacia Thermowood Acacia termizzato	TABLE.PENNY2	13.538
Swamp oak Rovere di palude		

Cappuccino sanded Cappuccino sabbaiato	TABLE.PENNY2	18.569
Black fantasy brushed Black fantasy spazzolato		
Egeo stone, textured glossy Egeo ondulato lucido		
Egeo stone, textured brushed Egeo ondulato spazzolato		

* Any request for monolithical top, has to be assessed by reference to the choosen material and the availability of the slab at the moment of the order confirmation. Eventuali richieste del top in lastra unica da valutare in riferimento al tipo di materiale e alla disponibilità delle lastre alla conferma dell'ordine.

Soprano



Structure

Solid wood

Finish

Heat treated woods as our samples and Swamp Oak oil finish based on natural wax and water
Leather with finishes from the samples available.

Wood Top

Solidwood top, thickness 2 cm surround profile with lowered section.

Finish

Heat treated woods as our samples and Swamp Oak oil finish based on natural wax and water

Stone Top

Top in stone thickness 2 cm surround profile with lowered section. [4 pieces book matched]

Finish

Marble stones and granites as per our samples.

DIMENSIONS

160 cm x 110 cm x 77 cm
160 cm x 160 cm x 77 cm
180 cm x 180 cm x 77 cm
180 cm x 110 cm x 77 cm
210 cm x 110 cm x 77 cm
240 cm x 110 cm x 77 cm
300 cm x 110 cm x 77 cm

Struttura

Legno massello

Finitura

Legni termotrattati nelle finiture a campionario e rovere di palude, finiti ad olio a base di cera naturale e acqua.
Pelle nelle finiture di gamma a campionario.

Piano in legno

In legno listellare spessore 2 cm profilo perimetrale a sezione ribassata.

Finitura

Legni termotrattati nelle finiture a campionario e rovere di palude, finiti ad olio a base di cera naturale e acqua.

Piano in pietra

In pietra spessore 2 cm profilo perimetrale a sezione ribassata [4 pezzi a macchia aperta].

Finitura

Marmi e graniti nei colori e nelle finiture a campionario.

DIMENSIONI

160 cm x 110 cm x 77 cm
160 cm x 160 cm x 77 cm
180 cm x 180 cm x 77 cm
180 cm x 110 cm x 77 cm
210 cm x 110 cm x 77 cm
240 cm x 110 cm x 77 cm
300 cm x 110 cm x 77 cm

Table . Tavolo 160x110

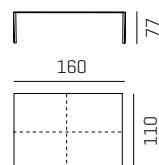

Wood species . Essenze

Wood species . Essenze	Code Codice	Thermowood Legni termizzati	Swamp oak Rovere di palude	Leather . Pelle cat. 300	Leather . Pelle cat. 400
Oak Thermowood Rovere termizzato Eucalyptus Thermowood Eucalipto termizzato	SOPR.1290	3.199	-	3.961	4.064
Eucalyptus Thermowood Eucalipto nero termizzato Acacia Thermowood Acacia termizzato					
Swamp oak Rovere di palude		-	3.784	4.548	4.651

Marble and stone . Marmi e pietre

Marble and stone . Marmi e pietre	Code Codice	Thermowood Legni termizzati	Swamp oak Rovere di palude	Leather . Pelle cat. 300	Leather . Pelle cat. 400
Gray Stone smooth Gray Stone levigato	SOPR.1290	5.622	6.208	6.385	6.487
Cappuccino sanded Cappuccino sabbiato Meteorus Egeo Black fantasy					
		7.178	7.765	7.941	8.037

Table . Tavolo 180x110

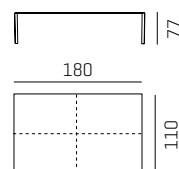

Wood species . Essenze

Wood species . Essenze	Code Codice	Thermowood Legni termizzati	Swamp oak Rovere di palude	Leather . Pelle cat. 300	Leather . Pelle cat. 400
Oak Thermowood Rovere termizzato Eucalyptus Thermowood Eucalipto termizzato	SOPR.1300	3.587	-	4.272	4.379
Black Eucalyptus Thermowood Eucalipto nero termizzato Acacia Thermowood Acacia termizzato					
Swamp oak Rovere di palude		-	4.272	4.909	5.016

Marble and stone . Marmi e pietre

Marble and stone . Marmi e pietre	Code Codice	Thermowood Legni termizzati	Swamp oak Rovere di palude	Leather . Pelle cat. 300	Leather . Pelle cat. 400
Gray Stone smooth Gray Stone levigato	SOPR.1300	6.299	6.938	6.985	7.091
Cappuccino sanded Cappuccino sabbiato Meteorus Egeo Black fantasy					
		8.674	9.311	9.360	9.478

Table . Tavolo 210x110

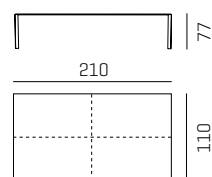

Wood species . Essenze

Wood species . Essenze	Code Codice	Thermowood Legni termizzati	Swamp oak Rovere di palude	Leather . Pelle cat. 300	Leather . Pelle cat. 400
Oak Thermowood Rovere termizzato Eucalyptus Thermowood Eucalipto termizzato	SOPR.1305	4.163	-	4.704	4.814
Black Eucalyptus Thermowood Eucalipto nero termizzato Acacia Thermowood Acacia termizzato					
Swamp oak Rovere di palude		-	4.879	5.419	5.530

Marble and stone . Marmi e pietre

Marble and stone . Marmi e pietre	Code Codice	Thermowood Legni termizzati	Swamp oak Rovere di palude	Leather . Pelle cat. 300	Leather . Pelle cat. 400
Gray Stone smooth Gray Stone levigato	SOPR.1305	6.996	7.711	7.536	7.647
Cappuccino sanded Cappuccino sabbiato Meteorus Egeo Black fantasy					
		9.602	10.317	10.048	10.143

* Any request for monolithical top, has to be assessed by reference to the choosen material and the availability of the slab at the moment of the order confirmation.
Eventuali richieste del top in lastra unica da valutare in riferimento al tipo di materiale e alla disponibilità delle lastre alla conferma dell'ordine.

Soprano

Finishes Top Finitura Top	Code . Codice	Thermowood Legni termizzati	Swamp oak Rovere di palude	Leather . Pelle cat. 300	Leather . Pelle cat. 400
Structure . Struttura					

Table . Tavolo 240 x 110 *

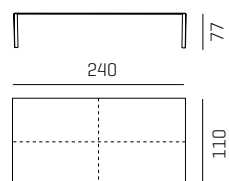

Wood species . Essenze

Oak Thermowood Rovere termizzato	SOPR.1310	4.544	-	5.016	5.132
Eucalyptus Thermowood Eucalipto termizzato					
Black Eucalyptus Thermowood Eucalipto nero termizzato	SOPR.1310	-	5.343	5.816	5.931
Acacia Thermowood Acacia termizzato					
Swamp oak Rovere di palude					

Marble and stone . Marmi e pietre

Gray Stone smooth Gray Stone levigato	SOPR.1310	7.977	8.776	8.449	8.564
Cappuccino sanded Cappuccino sabbato		11.108	11.907	11.579	11.692
Meteorus Egeo Black fantasy					

Table . Tavolo 300 x 110

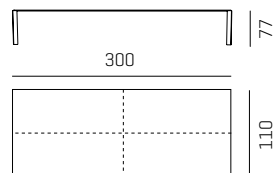

Wood species . Essenze

Oak Thermowood Rovere termizzato	SOPR.1315	5.054	-	5.472	5.592
Eucalyptus Thermowood Eucalipto termizzato					
Black Eucalyptus Thermowood Eucalipto nero termizzato	SOPR.1315	-	5.801	6.219	6.339
Acacia Thermowood Acacia termizzato					
Swamp oak Rovere di palude					

Marble and stone . Marmi e pietre

Gray Stone smooth Gray Stone levigato	SOPR.1315	9.760	10.507	10.176	10.298
Cappuccino sanded Cappuccino sabbato		13.481	14.229	13.899	14.017
Meteorus Egeo Black fantasy					

* Any request for monolithical top, has to be assessed by reference to the choosen material and the availability of the slab at the moment of the order confirmation.
Eventuali richieste del top in lastra unica da valutare in riferimento al tipo di materiale e alla disponibilità delle lastre alla conferma dell'ordine.

Soprano

Finishes Top Finitura Top	Code . Codice	Thermowood Legni termizzati	Swamp oak Rovere di palude	Leather . Pelle cat. 300	Leather . Pelle cat. 400
Structure . Struttura					

Table . Tavolo 160 x 160

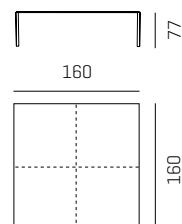

Wood species . Essenze

Oak Thermowood Rovere termizzato	SOPR.1260	4.199	-	4.679	4.788
Eucalyptus Thermowood Eucalipto termizzato					
Black Eucalyptus Thermowood Eucalipto nero termizzato	SOPR.1260	-	4.947	5.429	5.537
Acacia Thermowood Acacia termizzato					
Swamp oak Rovere di palude					

Marble and stone . Marmi e pietre

Gray Stone smooth Gray Stone levigato	SOPR.1260	7.703	8.452	8.184	8.292
Cappuccino sanded Cappuccino sabbaiato		10.727	11.477	11.209	11.316
Meteorus Egeo Black fantasy					

Table . Tavolo 180 x 180

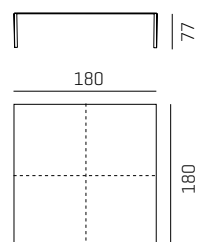

Wood species . Essenze

Oak Thermowood Rovere termizzato	SOPR.1265	4.867	-	5.185	5.299
Eucalyptus Thermowood Eucalipto termizzato					
Black Eucalyptus Thermowood Eucalipto nero termizzato	SOPR.1265	-	5.672	5.989	6.104
Acacia Thermowood Acacia termizzato					
Swamp oak Rovere di palude					

Marble and stone . Marmi e pietre

Gray Stone smooth Gray Stone levigato	SOPR.1265	8.708	9.512	9.024	9.140
Cappuccino sanded Cappuccino sabbaiato		11.637	12.441	11.620	11.954
Meteorus Egeo Black fantasy					

Stone Table

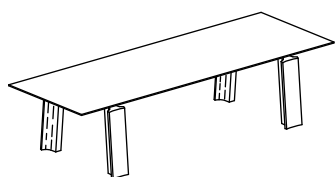
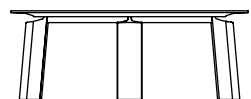

Table . Tavolo D. 200x75

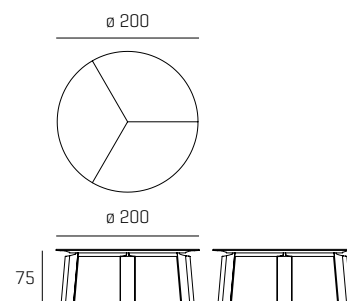

TABLE.STONE01	8.773	9.923	22.958
---------------	-------	-------	--------

Table . Tavolo 320x110x75 cm

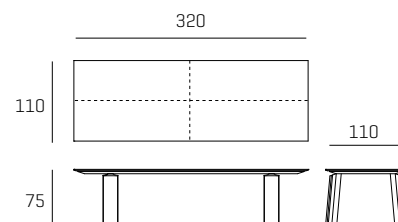

TABLE.STONE02	9.359	10.055	26.433
---------------	-------	--------	--------

Structure

Black paint steel pipe

Top Finish

Heat treated woods as our samples and Swamp Oak oil finish based on natural wax and water Thickness 2 cm. Cappuccino stone, sand-sprayed and brushed, thickness 2 cm

Legs Finish

Heat treated woods as our samples and Swamp Oak oil finish based on natural wax and water. Thickness 2 cm. Cappuccino stone, sand-sprayed and brushed, thickness 2 cm

DIMENSIONI

D. 200 cm x 75 cm h
320 cm x 110 cm x 75 cm h

Struttura

Tubolare in acciaio verniciato nero

Finitura - Piano

Legni termotrattati nelle finiture a campionario e rovere di palude, finiti ad olio a base di cera naturale e acqua. Spessore 2 cm. Pietra Cappuccino idrosabbato spazzolato, spessore 2 cm

DIMENSIONI

D. 200 cm x 75 cm h
320 cm x 110 cm x 75 cm h

Light Ring

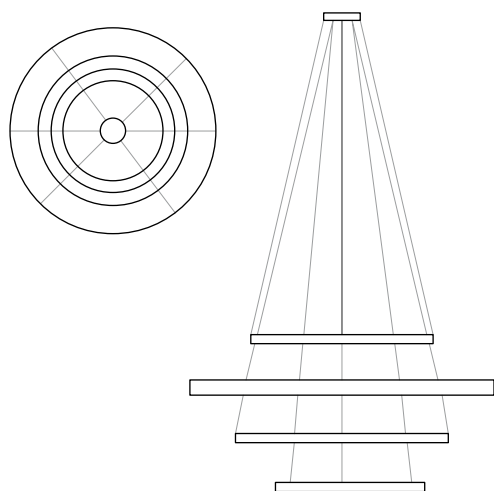

Certified Product
Prodotto certificato



Dimmable pendant led lamp (energy efficiency index A), energy saving with warm light, in several compositions made up of burnished finish brass rings or black burnished finish steel rings. Handmade with traditional craftsmanship, available in different sizes and types of light emission; transformers inserted in the ceiling rosette, rings powered with low voltage through suspension wires.

3 ring composition (from top to bottom)

1 x Ø 60 cm ring with upward pointing led; 23W - 1728Lm - 3000K
2 x Ø 70 cm rings with centre pointing leds; 30W 2268Lm - 3000K
3 x Ø 50 cm rings with downward pointing leds; 20W 1512Lm - 3000K
Total 73W 5508Lm. Minimum overall height 90 cm

4 ring composition (from top to bottom)

1 x Ø 60 cm ring with upward pointing led; 23W - 1728Lm - 3000K
2 x Ø 100 cm rings with or without upward pointing leds; 40W - 3024Lm - 3000K
3 x Ø 70 cm rings with central pointing leds; 30W 2268Lm 3000K
4 x Ø 50 cm rings with downward pointing leds; 20W - 1512Lm - 3000K
Total 73W 5508Lm. Minimum overall height 120 cm. Total Full Led 113W 8308Lm

Lampada sospensione a led (classe energetica tipo A), dimmerabile, basso consumo con luce calda, in varie composizioni formata da anelli profilati in ottone finitura brunita, o acciaio brunito nero. Secondo le tecniche tradizionali realizzata a mano in diverse misure e tipologie di emissione luminosa; trasformatori inseriti nel rosone, alimentazione degli anelli a bassa tensione realizzata tramite i cavi di sospensione.

Composizione a 3 anelli (dal'alto verso il basso)

1 anello da Ø 60 cm con led rivolti verso l'alto potenza; 23W - 1728Lm - 3000K
2 anello da Ø 70 cm con led rivolti verso il centro potenza; 30W - 2268Lm - 3000K
3 anello da Ø 50 cm con led rivolti verso il basso potenza; 20W 1512Lm - 3000K
Totale 73W 5508Lm. Sviluppo minimo 90 cm

Composizione a 4 anelli (dal'alto verso il basso)

1 anello da Ø 60 cm con led rivolti verso l'alto potenza; 23W - 1728Lm - 3000K
2 anello da Ø 100 cm con o senza led rivolti verso l'alto potenza; 40W - 3024Lm - 3000K
3 anello da Ø 70 cm con led rivolti verso il centro potenza; 30W - 2268Lm - 3000K
4 anello da Ø 50 cm con led rivolti verso il basso potenza; 20W - 1512Lm - 3000K
Sviluppo minimo 120 cm. Totale 73W 5508Lm. Totale Full Led 113W 8308Lm

Code . Codice	Burnished steel Acciaio brunito	Burnished brass Ottone brunito	Box Size Dms scatola	Weight Kg Peso Kg
---------------	------------------------------------	-----------------------------------	-------------------------	----------------------

Light Ring Medium (3 ring . anelli)

LIGHT.RING.02 [CE]
LIGHT.RING.02 [UL]

3.950 4.748
5.052 5.872

77 x 77 x 22

brass . ottone
15 Kg

steel . ferro
19 Kg

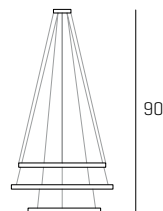

* Upgraded version 112W 10250 Lm: 260 euro net price

Light Ring Maxi (4 ring . anelli)

LIGHT.RING.01 [CE]
LIGHT.RING.01 [UL]

5.102 6.255
6.205 7.358

108 x 108 x 22

brass . ottone
24 Kg

steel . ferro
31 Kg

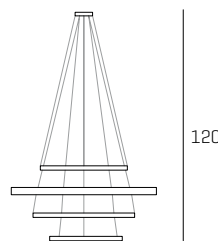

* Upgraded version 112W 10250 Lm: 260 euro net price

Light Ring Maxi Full Led Ø 100 cm ring with upward pointing leds Light Ring Maxi Full Led con anello Ø 100 cm elettrificato

LIGHT.RING.03 [CE]
LIGHT.RING.03 [UL]

5.561 6.605
7.045 8.089

108 x 108 x 24

brass . ottone
24 Kg

steel . ferro
31 Kg

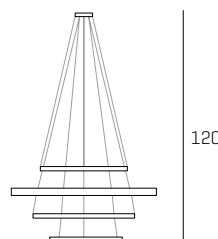

* Upgraded version 169W 15470 Lm: 390 euro net price

* 2700K available at the same price.
2700K Disponibile senza maggiorazione di prezzo.

* CE Certified Light Ring available with 110 V and 220 V
Disponibile il Light Ring Certificato CE 110/220 V

Code . Codice	Burnished steel Acciaio brunito	Burnished brass Ottone brunito	Box Size Dms scatola	Weight Kg Peso Kg
---------------	------------------------------------	-----------------------------------	-------------------------	----------------------

8 ring composition (from top to bottom)

1 X Ø 70 cm ring with central pointing led; 30W - 2268Lm - 3000K
 2 X Ø 60 cm ring with upward pointing led; 23W - 1728Lm - 3000K
 3 X Ø 100 cm ring with or without upward pointing led;
 40W - 3024Lm - 3000K
 4 X Ø 70 cm ring with central pointing led; 30W - 2268Lm - 3000K
 5 X Ø 60 cm ring with upward pointing led; 23W - 1728Lm - 3000K
 6 X Ø 100 cm ring with or without upward pointing led;
 40W - 3024Lm - 3000K
 7 X Ø 60 cm ring with upward pointing led; 23W - 1728Lm - 3000K
 8 X Ø 50 cm ring with downward pointing led; 20W - 1512Lm - 3000K
 Minimum overall height 280 cm
 Total 149W - 11.232Lm
 Total Full Led 229W - 17.280Lm

Composizione da 8 anelli (dall'alto verso il basso)

1 anello x Ø 70 cm con led rivolti verso il centro; 30W - 2268Lm - 3000K
 2 anello x Ø 60 cm con led rivolti verso l'alto; 23W - 1728Lm - 3000K
 3 anello x Ø 100 cm con o senza led rivolti verso l'alto;
 40W - 3024Lm - 3000K
 4 anello x Ø 70 cm con led rivolti verso il centro; 30W - 2268Lm - 3000K
 5 anello x Ø 60 cm con led rivolti verso l'alto; 23W - 1728Lm - 3000K
 6 anello x Ø 100 cm con o senza led rivolti verso l'alto;
 40W - 3024Lm - 3000K
 7 anello x Ø 60 cm con led rivolti verso l'alto; 23W - 1728Lm - 3000K
 8 anello x Ø 50 cm con led rivolti verso il basso; 20W - 1512Lm - 3000K
 Sviluppo minimo 280 cm
 Totale 149W - 11.232Lm
 Totale Full Led 229W - 17.280Lm

12 ring composition (from top to bottom)

1 X Ø 70 cm ring with central pointing led; 30W - 2268Lm - 3000K
 2 X Ø 100 cm ring with downward pointing led; 40W - 3024Lm - 3000K
 3 X Ø 70 cm ring with central pointing led; 30W - 2268Lm - 3000K
 4 X Ø 60 cm ring with downward pointing led; 23W - 1728Lm - 3000K
 5 X Ø 100 cm ring with upward pointing led; 40W - 3024Lm - 3000K
 6 X Ø 70 cm ring with central pointing led; 30W - 2268Lm - 3000K
 7 X Ø 60 cm ring with upward pointing led; 23W - 1728Lm - 3000K
 8 X Ø 100 cm ring with downward pointing led; 40W - 3024Lm - 3000K
 9 X Ø 60 cm ring with downward pointing led; 23W - 1728Lm - 3000K
 10 X Ø 70 cm ring with central pointing led; 30W - 2268Lm - 3000K
 11 X Ø 60 cm ring with upward pointing led; 23W - 1728Lm - 3000K
 12 X Ø 50 cm ring with downward pointing led; 20W - 1512Lm - 3000K
 Minimum overall height 400 cm
 Total 352W - 26.568Lm

Composizione da 12 anelli (dall'alto verso il basso)

1 anello x Ø 70 cm con led rivolti verso il centro; 30W - 2268Lm - 3000K
 2 anello x Ø 100 cm con led rivolti verso il basso; 40W - 3024Lm - 3000K
 3 anello x Ø 70 cm con led rivolti verso il centro; 30W - 2268Lm - 3000K
 4 anello x Ø 60 cm con led rivolti verso il basso; 23W - 1728Lm - 3000K
 5 anello x Ø 100 cm con led rivolti verso l'alto; 40W - 3024Lm - 3000K
 6 anello x Ø 70 cm con led rivolti verso il centro; 30W - 2268Lm - 3000K
 7 anello x Ø 60 cm con led rivolti verso l'alto; 23W - 1728Lm - 3000K
 8 anello x Ø 100 cm con led rivolti verso il basso; 40W - 3024Lm - 3000K
 9 anello x Ø 60 cm con led rivolti verso il basso; 23W - 1728Lm - 3000K
 10 anello x Ø 70 cm con led rivolti verso il centro; 30W - 2268Lm - 3000K
 11 anello x Ø 60 cm con led rivolti verso l'alto; 23W - 1728Lm - 3000K
 12 anello x Ø 50 cm con led rivolti verso il basso; 20W - 1512Lm - 3000K
 Sviluppo minimo 400 cm
 Totale 352W - 26.568Lm

Light Ring XXL (8 ring . anelli)	LIGHT.RING.04 (CE)	12.195	14.039	108 x 108 x 26	brass . ottone 42 Kg
----------------------------------	--------------------	--------	--------	----------------	-------------------------

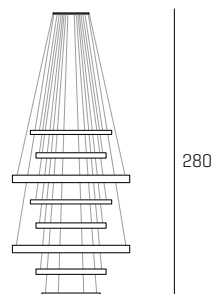

* Upgraded version 226W 20.700 Lm: 530 euro net price

Light Ring XXL Full Led	LIGHT.RING.05 (CE)	13.089	15.216	108 x 108 x 26	brass . ottone 42 Kg
-------------------------	--------------------	--------	--------	----------------	-------------------------

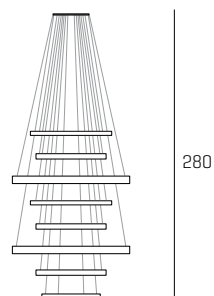

* Upgraded version 347W 31.750 Lm: 810 € net price

Dimmer Kit (DALI or DMX): 180 euro each net price

Light Ring XXL MAXI FULL LED (12 ring . anelli)	LIGHT.RING.18 (CE)	28.550	30.330	108 x 108 x 32	brass . ottone 56 Kg
--	--------------------	--------	--------	----------------	-------------------------

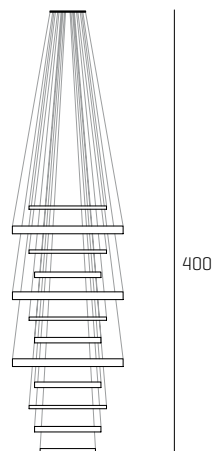

* Upgraded version 550W 50250 Lm: 1.200 € net price

* 2700K available at the same price.

2700K Disponibile senza maggiorazione di prezzo.

Different dimensions and finishes upon request . Dimensioni e finiture diverse disponibili su richiesta

Light Ring Wall

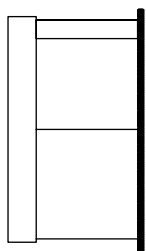

Code . Codice	Burnished steel Acciaio brunito	Burnished brass Ottone brunito	Box Size Dms scatola	Weight Kg Peso Kg
---------------	------------------------------------	-----------------------------------	-------------------------	----------------------

Light Ring Wall Ø40	LIGHT.RING.11 [CE]	1.400	1.720	58 x 58 x 24	brass . ottone
	LIGHT.RING.11 [UL]	1.594	1.914		5 Kg
					steel . ferro
					6 Kg

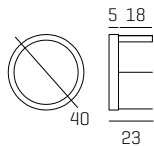

* Upgraded version 28W 2600 Lm: 90 euro net price

Light Ring Wall Ø70	LIGHT.RING.12 [CE]	1.824	2.229	77 x 77 x 24	brass . ottone
	LIGHT.RING.12 [UL]	2.019	2.424		8 Kg
					steel . ferro
					10 Kg

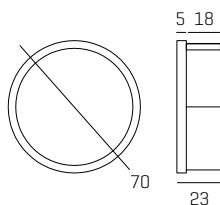

* Upgraded version 41W 3800 Lm: 110 euro net price

Light Ring Wall Ø100	LIGHT.RING.13 [CE]	2.290	2.911	108 x 108 x 24	brass . ottone
	LIGHT.RING.13 [UL]	2.484	3.105		14 Kg
					steel . ferro
					17 Kg

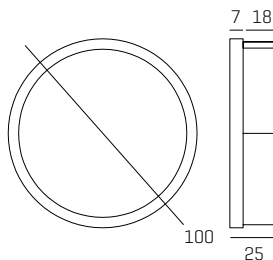

* Upgraded version 61W 5620 Lm: 150 euro net price

Kit for USA [not UL] . Kit per mercato USA	171	171			
--	-----	-----	--	--	--

* CE Certified lamps are available with 110 V on request at the same price. For US market they will need the Us Kit
UL Certified lamps are already included with Us Kit
È possibile avere la lampada certificata CE per il mercato USA utilizzando l'apposito Kit

* 2700K available at the same price.
2700K Disponibile senza maggiorazione di prezzo.

Wall sconce energy saving led lamp with warm light, (energy efficiency index A) formed with rings of various sizes and types of illumination; transformers incorporated in the wall junction box.

Finish

Black steel hand-burnished using traditional techniques.
Brass hand-burnished using traditional techniques.

Ring, Ø 40 cm, with leds pointing towards the wall; 19W 1400Lm - 3000K
Ring, Ø 70 cm, with leds pointing towards the wall; 27W 2000Lm - 3000K
Ring, Ø 100 cm, with leds pointing towards the wall; 41W 3000Lm - 3000K

Lampada a parete a led basso consumo [classe energetica tipo A] con luce calda, formata da anelli in diverse misure e tipologie di emissione luminosa; trasformatore inserito nel raccordo scatola.

Finitura

Acciaio brunito nero a mano secondo le tecniche tradizionali.
Ottone brunito a mano secondo le tecniche tradizionali

Anello da Ø 40 cm con led rivolti verso la parete; 19W 1400Lm - 3000K
Anello da Ø 70 cm con led rivolti verso la parete; 27W 2000Lm - 3000K
Anello da Ø 100 cm con led rivolti verso la parete; 41W 3000Lm - 3000K

Light Ring Horizontal

Certified Product
Prodotto certificato



Pendant energy saving led (energy efficiency index A) lamp with warm light, formed with rings of various sizes and types of illumination; incorporating transformers in the ceiling rosette, low voltage power supply to the rings through the suspension cables. Standard overall height 180 cm

Finish

Black steel hand-burnished using traditional techniques.
Brass hand-burnished using traditional techniques.





Ring Ø 40 cm with leds pointing downward; 19W 1400Lm 3000K
Ring Ø 50 cm with leds pointing downward; 23W 1700Lm 3000K
Ring Ø 60 cm with leds pointing downward; 27,5W 2050Lm 3000K
Ring Ø 70 cm with leds pointing downward; 31W 2270Lm 3000K
Ring Ø 100 cm with leds pointing downward; 45W 3350Lm 3000K

Lampada a sospensione a led (classe energetica tipo A) basso consumo con luce calda, formata da anelli in diverse misure e tipologie di emissione luminosa; trasformatori inseriti nel rosone, alimentazione degli anelli a bassa tensione realizzata tramite i cavi di sospensione.
Sviluppo standard 180 cm

Finitura

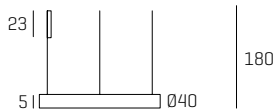
Acciaio brunito nero a mano secondo le tecniche tradizionali.
Ottone brunito a mano secondo le tecniche tradizionali.

Anello da Ø 40 cm con led rivolti verso il basso; 19W 1400Lm 3000K
Anello da Ø 50 cm con led rivolti verso il basso; 23W 1700Lm 3000K
Anello da Ø 60 cm con led rivolti verso il basso; 27,5W 2050Lm 3000K
Anello da Ø 70 cm con led rivolti verso il basso; 31W 2270Lm 3000K
Anello da Ø 100 cm con led rivolti verso il basso; 45W 3350Lm 3000K

	Code . Codice	Burnished steel Acciaio brunito	Burnished brass Ottone brunito	Box Size Dms scatola	Weight Kg Peso Kg
Light Ring horizontal Ø40 	LIGHT.RING.06 (CE)	1.400	1.720	47 x 47 x 22	brass . ottone 5 Kg
	LIGHT.RING.06 (UL)	1.659	1.979		
* Upgraded version 28W 2600 Lm: 90 € net price					
Light Ring horizontal Ø50 	LIGHT.RING.07 (CE)	1.522	1.874	77 x 77 x 22	brass . ottone 6 Kg
	LIGHT.RING.07 (UL)	1.781	2.133		
* Upgraded version 35W 3216 Lm: 90 € net price					
Light Ring horizontal Ø60 	LIGHT.RING.08 (CE)	1.775	2.041	77 x 77 x 22	brass . ottone 7 Kg
	LIGHT.RING.08 (UL)	2.034	2.301		
* Upgraded version 41W 3800 Lm: 90 € net price					
Light Ring horizontal Ø70 	LIGHT.RING.09 (CE)	1.972	2.228	77 x 77 x 22	brass . ottone 8 Kg
	LIGHT.RING.09 (UL)	2.166	2.488		
* Upgraded version 49W 4220 Lm: 110 € net price					
Light Ring horizontal Ø100 	LIGHT.RING.10 (CE)	2.508	2.878	108 x 108 x 22	brass . ottone 14 Kg
	LIGHT.RING.10 (UL)	2.702	3.137		
* Upgraded version 68W 6230 Lm: 150 € net price					
Kit for USA (not UL) . Kit per mercato USA		171	171		
Dimmer Kit (DALI or DMX): 180 euro each net price Composition with unique separated transformer (from 2 to 5 pcs): 380 euro net price Composition with unique separated transformer (from 6 to 10 pcs): 570 euro net price Extra length height (more than 180 cm): 60 euro net price					

* 2700K available at the same price. 2700K Disponibile senza maggiorazione di prezzo.
* È possibile avere la lampada certificata CE per il mercato USA utilizzando l'apposito Kit

Light Ring Horizontal

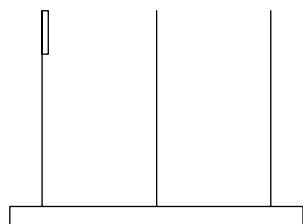

	Code . Codice	Burnished steel Acciaio brunito	Burnished brass Ottone brunito	Box Size Dms scatola	Weight Kg Peso Kg
Light Ring horizontal Ø120	LIGHT.RING.14 [CE]	4.027	4.328	147 x 147 x 22	brass . ottone 10 Kg steel . ferro 12 Kg
* Upgraded version 83W 7630 Lm: 150 euro net price					
Light Ring horizontal Ø140	LIGHT.RING.15 [CE]	4.436	4.760	147 x 147 x 22	brass . ottone 16 Kg steel . ferro 18 Kg
* Upgraded version 96W 8840 Lm: 150 euro net price					
Light Ring horizontal Ø160	LIGHT.RING.16 [CE]	4.937	5.286	187 x 187 x 22	brass . ottone 19 Kg steel . ferro 24 Kg
* Upgraded version 112W 10250 Lm: 150 euro net price					
Light Ring horizontal Ø180	LIGHT.RING.17 [CE]	5.768	6.159	187 x 187 x 22	brass . ottone 22 Kg steel . ferro 34 Kg
* Upgraded version 125W 11450 Lm: 175 euro net price					
Kit for USA [not UL] . Kit per mercato USA		171	171		
* È possibile avere la lampada certificata CE per il mercato USA utilizzando l'apposito Kit					
Dimmer Kit [DALI or DMX]: 180 euro each net price					
Composition with unique separated transformer (from 2 to 5 pcs): 380 euro net price					
Composition with unique separated transformer (from 6 to 10 pcs): 570 euro net price					
Extra length height (more than 180 cm): 60 euro net price					
* 2700K available at the same price . 2700K Disponibile senza maggiorazione di prezzo.					

Pendant energy saving led [energy efficiency index A] lamp with warm light, formed with rings of various sizes and types of illumination; incorporating transformers in the ceiling rosette, low voltage power supply to the rings through the suspension cables. Standard overall height 180 cm

Finish

Black steel hand-burnished using traditional techniques.
Brass hand-burnished using traditional techniques.

Ring Ø 120 cm with leds pointing downward; 54W 4100Lm 3000K
Ring Ø 140 cm with leds pointing downward; 63W 4750Lm 3000K
Ring Ø 160 cm with leds pointing downward; 73W 5500Lm 3000K
Ring Ø 180 cm with leds pointing downward; 82W 6150Lm 3000K

Lampada a sospensione a led [classe energetica tipo A] basso consumo con luce calda, formata da anelli in diverse misure e tipologie di emissione luminosa; trasformatore inseriti nel rosone, alimentazione degli anelli a bassa tensione realizzata tramite i cavi di sospensione.

Sviluppo standard 180 cm

Finitura

Acciaio brunito nero a mano secondo le tecniche tradizionali.
Ottone brunito a mano secondo le tecniche tradizionii.

Anello da Ø 120 cm con led rivolti verso il basso; 54W 4100Lm 3000K
Anello da Ø 140 cm con led rivolti verso il basso; 63W 4750Lm 3000K
Anello da Ø 160 cm con led rivolti verso il basso; 73W 5500Lm 3000K
Anello da Ø 180 cm con led rivolti verso il basso; 82W 6150Lm 3000K

Pipe Light-L

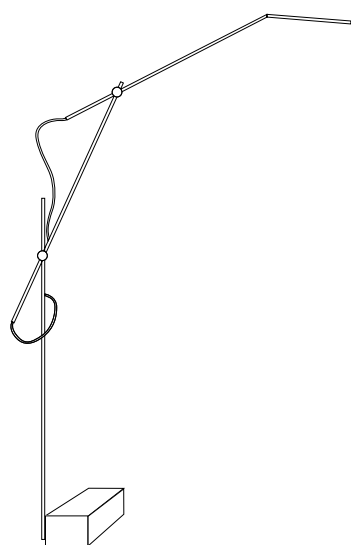

Pipe Light-L

LIGHT.PIPE.L

2.105

167 x 34 x 50

8 Kg

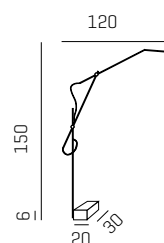

43 x 32 x 16

Basamento
marmo
10 Kg

Standard lamp, structure diameter 1,4 cm, multi directional and adjustable.

Stone base

Cappuccino sand-sprayed and brushed, thickness 2 cm, Meteorus sanded, thickness 2 cm incorporating a transformer, plaited power lead with red silk cover.

Energy saving warm light led [energy efficiency index A].

Finish

Brass hand-burnished using traditional techniques.

DIMENSIONS

120 cm x 19,5 cm x 150 cm

6W 565Lm - 3000K

Lampada da terra con struttura diametro 1,4 cm, orientabile e regolabile.

Basamento in pietra

Cappuccino idrosabbiato spazzolato, spessore 2 cm, Meteorus sabbiato, spessore 2 cm con inserimento del trasformatore, cavo di alimentazione a treccia con rivestimento in seta rossa.

Lampadina Led [classe energetica tipo A]

a luce calda basso consumo.

Finitura

Ottone brunito a mano secondo le tecniche tradizionali.

DIMENSIONI

120 cm x 19,5 cm x 150 cm

6W 565Lm - 3000K

Pipe Light-S

Pipe Light-S

LIGHT.PIPE.S

705
set of two
la coppia

37 x 27 x 23

3 Kg

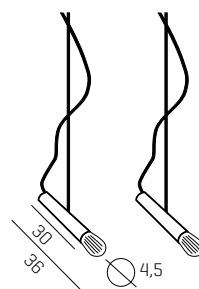

4,5 cm body diameter pendant lamp. Adjustable inclination, suspended with steel cable, plaited power lead with red silk cover. Dedicated E 27 tungsten light bulb, blown glass ampoule and visible filament shaped like an old carbon lamp. Standard overall height 250 cm [steel cable].

Finish

Brass hand-brushed using traditional techniques.

DIMENSIONS

36 cm x Ø 4,5 cm
220V 60W 350Lm
110V 60W 350Lm

Lampada a sospensione con corpo diametro 4,5 cm. Regolazione dell'inclinazione, sospensione con cavo di acciaio, alimentazione con cavo a treccia rivestito in seta rossa. Lampadina dedicata al tungsteno, E 27, ampolla in vetro soffiato e filamento visibile con le geometrie delle vecchie lampadine a carbone. Sviluppo standard 250 cm [cavi di acciaio].

Finitura

Ottone brunito a mano secondo le tecniche tradizionali.

DIMENSIONI

36 cm x Ø 4,5 cm
220V 60W 350Lm
110V 60W 350Lm

Tubular Light

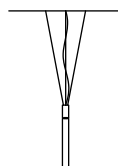

Single ceiling Tubular light. Dimmable Pendant energy saving led [GU 10] energy efficiency index A, lamp with natural light pointed downward; body diameters 5,5 cm, 7 cm and 10 cm. Tilting; steel suspension cables, plaited power lead with red silk cover. Standard overall height 180 cm (steel cable).

Finish

Brass hand-burnished using traditional techniques.

DIMENSIONS

48,5 cm x Ø 5.5 cm 5,3W 350Lm - 3000K

48,5 cm x Ø 7 cm 5,3W 350Lm - 3000K

48,5 cm x Ø 10 cm 5,3W 350Lm - 3000K

The UL Certified product is delivered without led bulb.

Tubular light singolo a soffitto.

Lampada a sospensione a led [GU 10] dimmerabile classe energetica tipo A, basso consumo con luce naturale rivolta verso il basso nei diametri 5,5 cm, 7 cm e 10 cm. Regolazione dell'inclinazione, sospensione con cavo di acciaio, alimentazione con cavo a treccia rivestito in seta rossa. Sviluppo standard 180 cm (cavi di acciaio).

Finitura

Ottone brunito a mano secondo le tecniche tradizionali.

DIMENSIONI

48,5 cm x Ø 5.5 cm 5,3W 350Lm - 3000K

48,5 cm x Ø 7 cm 5,3W 350Lm - 3000K

48,5 cm x Ø 10 cm 5,3W 350Lm - 3000K

Il prodotto certificato UL viene consegnato senza lampada Led.

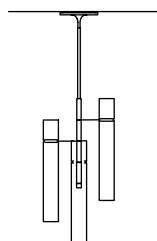

Ceiling Tubular light. Dimmable Pendant energy saving led [GU 10] classe energetica tipo A, lamp with natural light; body diameters 5,5 cm, 7,5 cm and 10 cm.

Composed of 3 identical elements, 6X5,3W 2100Lm 3000K; 3 elements Ø 5.5 cm with leds pointing upward and downward / full height 110 cm - light body 70 cm - diameter 32 cm. Standard overall height 130 cm.

Composed of 3 identical elements, 6X5,3W 2100Lm 3000K; 3 elements Ø 7 cm with leds pointing upward and downward - light body 70 cm - diametro 36 cm. Standard overall height 130 cm.

The UL Certified product is delivered without led bulb.

Tubular light a soffitto. Lampada a sospensione a led basso consumo [GU 10] dimmerabile classe energetica tipo A con luce calda corpo nei diametri 5,5 cm, 7,5 cm e 10 cm.

Composizione a 3 elementi uguali, Ø 5.5 cm - 6X5,3W 2100Lm 3000K; 3 elementi da Ø 5.5 cm con led rivolti verso l'alto e il basso / altezza totale 110 cm - corpo luce 70 cm - diametro 32 cm. Sviluppo standard 130 cm.

Composizione a 3 elementi uguali, Ø 7 cm - 6X5,3W 2100Lm 3000K; 3 elementi da Ø 7 cm con led rivolti verso l'alto e il basso - corpo luce 70 cm - diametro 36 cm. Sviluppo standard 130 cm.

Il prodotto certificato UL viene consegnato senza lampada Led.

Single ceiling element Elementi singoli a sospensione

Cylinders diameter . Diametro cilindro 5,5 cm

LIGHT.TUB001 [CE]

653

67 x 27 x 24

3 Kg

LIGHT.TUB001 [UL]

805

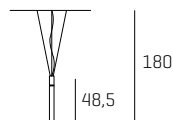

Cylinder diameter . Diametro cilindro 7 cm

LIGHT.TUB002 [CE]

680

67 x 27 x 24

4 Kg

LIGHT.TUB002 [UL]

832

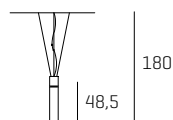

Cylinders diameter . Diametro cilindro 10 cm

LIGHT.TUB003 [CE]

702

67 x 27 x 24

4 Kg

LIGHT.TUB003 [UL]

853

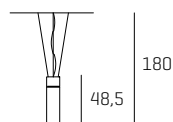

3 identical elements . 3 elementi uguali

Cylinders diameter . Diametro cilindri 5,5 cm

LIGHT.TUB004 [CE]

2.332

137 x 44 x 42

10 Kg

LIGHT.TUB004 [UL]

2.332

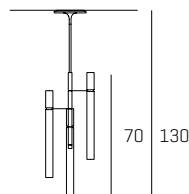

Cylinders diameter . Diametro cilindri 7 cm

LIGHT.TUB005 [CE]

2.405

137 x 44 x 42

11 Kg

LIGHT.TUB005 [UL]

2.405

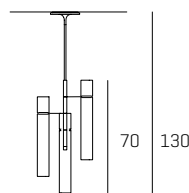

Prodotto certificato
Prodotto certificato



Tubular Light

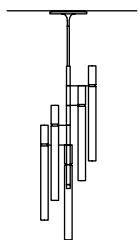

Composed of 5 identical elements, 10x5,3W 3500Lm 3000K; 5 elements Ø 5,5 cm with leds pointing upward and downward - light body 90 cm - diameter 32 cm.

Composed of 5 identical elements, 10x5,3W 3500Lm 3000K; 5 elements Ø 7 cm with leds pointing upward and downward - light body 90 cm - diameter 36 cm. Standard overall height 130 cm.

Composizione a 5 elementi uguali, Ø 5,5 cm - 10x5,3W 3500Lm 3000K; 5 elementi da Ø 5,5 cm con led rivolti verso l'alto e il basso / altezza totale 130 cm - corpo luce 90 cm - diametro 32 cm.

Composizione a 5 elementi uguali, Ø 7 cm 10x5,3W 3500Lm 3000K; 5 elementi da Ø 7 cm con led rivolti verso l'alto e il basso / altezza totale 130 cm - corpo luce 90 cm - diametro 36 cm. Sviluppo standard 130 cm.

The UL Certified product is delivered without led bulb.

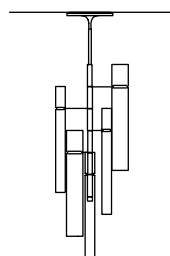

Composed of 5 different elements, 10x5,3W 3500Lm 3000K; 3 elements Ø 5,5 cm 2 elements, Ø 7 cm, with leds pointing upward and downward / full height 130 cm - light body 90 cm - diameter 36 cm. Standard overall height 130 cm.

Composed of 5 different elements, 10x5,3W 3500Lm 3000K; 2 elements Ø 5,5 cm 2 elements, Ø 7 cm, 1 element, Ø 10 cm, with leds pointing upward and downward / full height 130 cm - light body 90 cm - diameter 42 cm. Standard overall height 130 cm.

Composed of 5 different elements, 10x5,3W 3500Lm 3000K; 1 element Ø 5.5 cm 2 elements, Ø 7 cm, 2 elements, Ø 10 cm, with leds pointing upward and downward / full height 130 cm - light body 90 cm - diameter 42 cm. Standard overall height 130 cm.

Composizione a 5 elementi diversi, 10x5,3W 3500Lm 3000K; 3 elementi da Ø 5,5 cm. 2 elementi da Ø 7 cm con led rivolti verso l'alto e il basso - corpo luce 90 cm - diametro 36 cm. Sviluppo standard 130 cm.

Composizione a 5 elementi diversi, 10x5,3W 3500Lm 3000K; 2 elementi da Ø 5.5 cm, 2 elementi da Ø 7 cm, 1 elemento da Ø 10 cm con led rivolti verso l'alto e il basso / altezza totale 130 cm - corpo luce 90 cm - diametro 42 cm. Sviluppo standard 130 cm.

Composizione a 5 elementi diversi, 10x5,3W 3500Lm 3000K; 1 elemento da Ø 5,5 cm, 2 elementi da Ø 7 cm, 2 elementi da Ø 10 cm con led rivolti verso l'alto e il basso / altezza totale 130 cm - corpo luce 90 cm - diametro 42 cm. Sviluppo standard 130 cm.

Il prodotto certificato UL viene consegnato senza lampada Led.

5 identical elements . 5 elementi uguali

Cylinders diameter . Diametro cilindri 5,5 cm

LIGHT.TUB006 [CE]

3.674

137 x 44 x 42

13 Kg

LIGHT.TUB006 [UL]

3.674

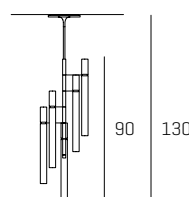

Cylinder diameter . Diametro cilindri 7 cm

LIGHT.TUB007 [CE]

3.924

137 x 44 x 42

15 Kg

LIGHT.TUB007 [UL]

3.924

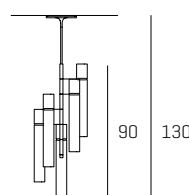

5 different elemets . 5 elementi diversi

3 cylinders diameter 5,5 cm, 2 cylinders 7 cm

LIGHT.TUB008 [CE]

3.779

137 x 44 x 42

15 Kg

3 cilindri diametro 5,5 cm, 2 cilindri 7 cm

LIGHT.TUB008 [UL]

3.779

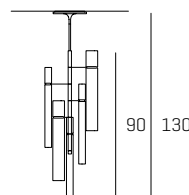

2 cylinders diameter 5,5 cm, 2 cylinders 7 cm,
1 cylinder 10 cm . 2 cilindri diametro 5,5 cm,
2 cilindri 7 cm, 1 cilindro 10 cm

LIGHT.TUB009 [CE]

3.869

137 x 44 x 42

15 Kg

LIGHT.TUB009 [UL]

3.869

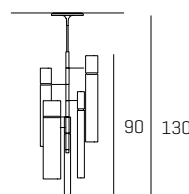

1 cylinder diameter 5,5 cm, 2 cylinders 7 cm, 2
cylinders 10 cm . 1 cilindro diametro 5,5 cm,
2 cilindri 7 cm, 2 cilindri 10 cm

LIGHT.TUB010 [CE]

3.960

137 x 44 x 42

15 Kg

LIGHT.TUB010 [UL]

3.960

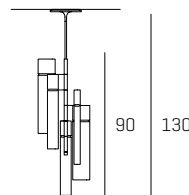

Code . Codice	Brass . Ottone	Box Size Dms scatola	Weight Kg Peso Kg
---------------	----------------	-------------------------	----------------------

Tubular Light Ceiling - Floor . Cielo - Terra

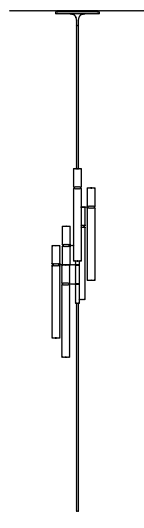

6 elements diameter 5,5 cm
6 elementi diametro 5,5 cm

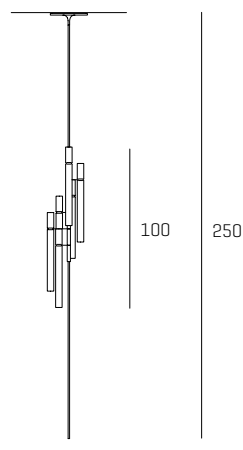

LIGHTTUB011 [CE]	4.096	260 x 44 x 42	17 Kg
LIGHTTUB011 [UL]	4.096		

3 elements: diameter 7 cm
3 elementi: diametro 7 cm

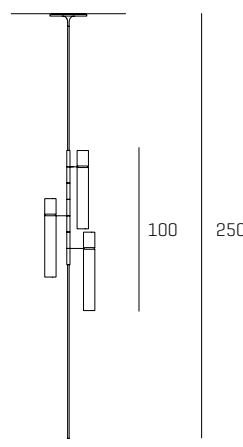

LIGHTTUB012 [CE]	3.402	260 x 44 x 42	14 Kg
LIGHTTUB012 [UL]	3.402		

Certified Product
Prodotto certificato



Ceiling - standard lamp, energy saving led lamp (energy efficiency index A) with warm light, body diameter 5,5 cm, 7 cm.

Composed of 6 identical elements, 12X5,3W 4200Lm 6 elements Ø 5.5 cm with leds pointing upward and downward - light body 100 cm - diameter 32 cm. Standard overall height 250 cm.

Composed of 3 identical elements, 12X5,3W 4200Lm 3 elements Ø 7 cm with leds pointing upward and downward - light body 100 cm - diameter 36 cm.

Standard overall height 250 cm.

The UL Certified product is delivered without led bulb.

Lampada a soffitto - pavimento a led (classe energetica tipo A) basso consumo con luce calda, corpo nei diametri 5,5 cm, 7 cm.

Composizione a 6 elementi uguali 12X5,3W 4200Lm 6 elementi da Ø 5.5 cm con led rivolti verso l'alto e il basso - corpo luce 100 cm - diametro 32 cm. Sviluppo standard 250 cm.

Composizione a 3 elementi uguali 12X5,3W 4200Lm 3 elementi da Ø 7 cm con led rivolti verso l'alto e il basso - corpo luce 100 cm - diametro 36 cm. Sviluppo standard 250 cm.

Il prodotto certificato UL viene consegnato senza lampada Led.

Code . Codice	Brass . Ottone	Box Size Dms scatola	Weight Kg Peso Kg
---------------	----------------	-------------------------	----------------------

Tubular Light Wall . A parete

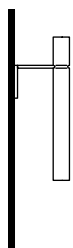

Diameter . Diametro 5,5 cm

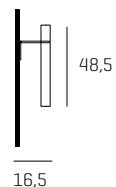

LIGHT.TUB013 [CE]

729

67 x 27 x 24

3 Kg

LIGHT.TUB013 [UL]

815

Diameter . Diametro 7 cm

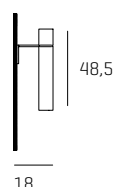

LIGHT.TUB014 [CE]

745

67 x 27 x 24

3 Kg

LIGHT.TUB014 [UL]

832

Certified Product
Prodotto certificato



82

Single wall tubular light.

Energy saving led [energy efficiency index A] lamp with warm light; downward, upward lighting; body diameters 5,5 cm, 7 cm.

Finish

Brass hand-brushed using traditional techniques.

DIMENSIONI

48,5 cm x Ø 5,5 cm x 16,5 cm [distance from wall]

2X5,3W 700Lm 3000K.

48,5 cm x Ø 7 cm x 18 cm [distance from wall]

2X5,3W 700Lm 3000K.

The UL Certified product is delivered without led bulb.

Tubular light singolo a parete.

Lampada a led [classe energetica tipo A] basso consumo con luce calda. Illuminazione verso il basso e verso l'alto, corpo nei diametri 5,5 cm, 7 cm.

Finitura

Ottone brunito a mano secondo le tecniche tradizionali.

DIMENSIONI

48,5 cm x Ø 5,5 cm x 16,5 cm [distanza dalla parete]

2X5,3W 700Lm 3000K.

48,5 cm x Ø 7 cm x 18 cm [distanza dalla parete]

2X5,3W 700Lm 3000K.

Il prodotto certificato UL viene consegnato senza lampada Led.

U-Light

LIGHT.U001

3.406

72 x 72 x 38

12 Kg

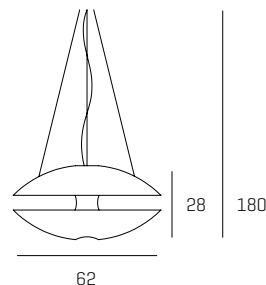
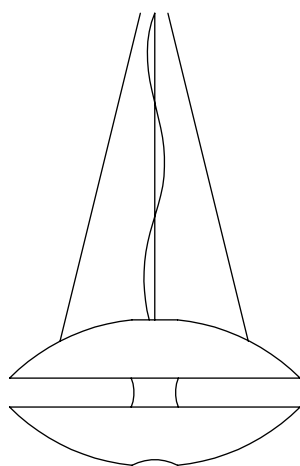

Pendant energy saving led [energy efficiency index A] lamp with warm light; body diameter 62; steel suspension cable, plaited and with red silk cover.

Standard overall height 180 cm [steel cable].

Finish

Exterior in brass hand-burnished using traditional techniques.

Interior, white paint finish.

Insight lamp 7W - 680Lm - 3.000K;

Lower lamp 7W - 680Lm - 3.000K

DIMENSIONS

62 cm x 28 cm

Lampada a sospensione a led [classe energetica tipo A] basso consumo con luce calda corpo diametro 62 cm sospensione con cavo di acciaio, alimentazione con cavo a treccia rivestito in seta rossa.

Sviluppo standard 180 cm [cavi di acciaio].

Finitura

Esterno in Ottone brunito a mano secondo le tecniche tradizionali.

Interno verniciato bianco.

Lampada interna 7W - 680Lm - 3.000K;

Lampada inferiore 7W- 680Lm - 3.000K

DIMENSIONI

62 cm x 28 cm

Y-Light

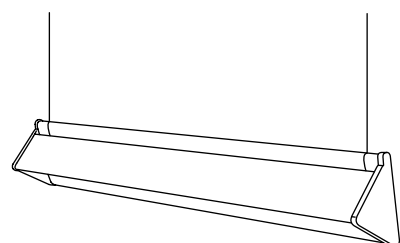

Downward light . Luce verso il basso L 60 cm

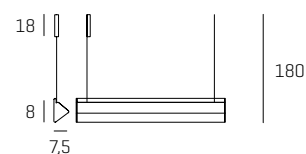

LIGHT.Y001

1.289

700 x 12 x 12

3 Kg

Upward light . Luce verso l'alto L 60 cm

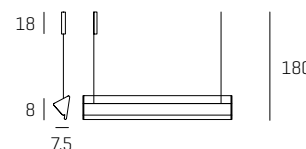

LIGHT.Y002

1.289

700 x 12 x 12

3 Kg

Downward light . Luce verso il basso L 90 cm



LIGHT.Y003

1.588

1000 x 12 x 12

4 Kg

Upward light . Luce verso l'alto L 90 cm



LIGHT.Y004

1.588

1000 x 12 x 12

4 Kg

Kit per mercato USA

171

Pendant energy saving led [energy efficiency index A] lamp with warm light, Y-shaped body, steel suspension cables. Standard overall height 180 cm [steel cable].

Finish

Structure in brass hand-burnished using traditional techniques. With cover in burnished steel mesh tweed pattern.

Lamp 60 cm 12W 1165Lm 3.000K;

Lamp 90 cm 18W 1680Lm 3.000K.

DIMENSIONI

60 cm x 7,5 cm x 8 cm

90 cm x 7,5 cm x 8 cm

Lampada a sospensione a led [classe energetica tipo A] basso consumo con luce calda, corpo sagomato a Y, sospensione con cavo di acciaio.

Sviluppo standard 180 cm [cavi di acciaio].

Finitura

Struttura in ottone brunito a mano secondo le tecniche tradizionali. Rivestita in maglia d'acciaio tweed brunita.

Lampada 60 cm 12W 1165Lm 3.000K;

Lampada 90 cm 18W 1680Lm 3.000K.

DIMENSIONI

60 cm x 7,5 cm x 8 cm

90 cm x 7,5 cm x 8 cm

Light Disc

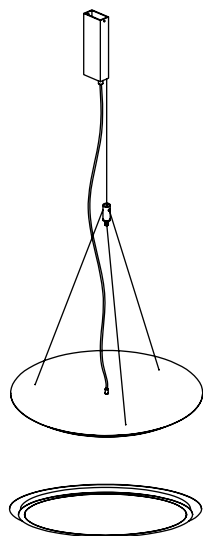

Pendant LED lamp, [energy efficiency index A] dimmable, energy-saving, warm light, adjustable inclination, suspended with steel cable, plaited power lead with red silk cover. Available in several sizes and lighting versions; transformers incorporated into the ceiling rose.

Finish

Brass finish, hand-burnished using traditional techniques.

DIMENSIONS

Disco Ø 96 cm power 57W - 5220Lm - 3000K

Disco Ø 73 cm power 41W - 3800Lm - 3000K

Disco Ø 49 cm power 26W - 2412Lm - 3000K

Disco Ø 34 cm power 15W - 1366Lm - 3000K

Lampada sospensione a led, [classe energetica tipo A] dimmerabile, basso consumo con luce calda, Regolazione dell'inclinazione, sospensione con cavo di acciaio, alimentazione con cavo a treccia rivestito in seta rossa. Disponibile in diverse misure e tipologie di emissione luminosa; trasformatori inseriti nel rosone.

Finitura

Ottone brunito a mano secondo le tecniche tradizionali.

DIMENSIONI

Disco Ø 96 cm potenza 57W - 5220Lm - 3000K

Disco Ø 73 cm potenza 41W - 3800Lm - 3000K

Disco Ø 49 cm potenza 26W - 2412Lm - 3000K

Disco Ø 34 cm potenza 15W - 1366Lm - 3000K

Light Disc . Lampada disco Ø34

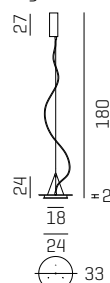

LIGHT.DISCO1

2.111

57 x 57 x 16

5 Kg

* Upgraded version 26W 2412Lm: 90 euro net price

Light Disc . Lampada disco Ø49

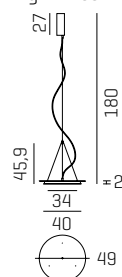

LIGHT.DISCO2

3.163

57 x 57 x 16

7 Kg

* Upgraded version 52W 4824Lm: 345 euro net price

Light Disc . Lampada disco Ø73

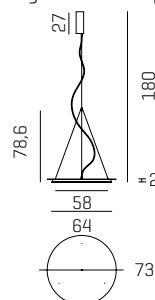

LIGHT.DISCO3

4.742

77 x 77 x 16

13 Kg

* Upgraded version 82W 7600Lm: 453 euro net price

Light Disc . Lampada disco Ø96

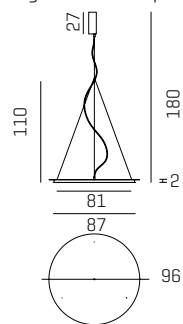

LIGHT.DISCO4

6.353

108 x 108 x 16

22 Kg

* Upgraded version 114W 10440Lm: 490 euro net price

Kit per mercato USA

171

Light Disc

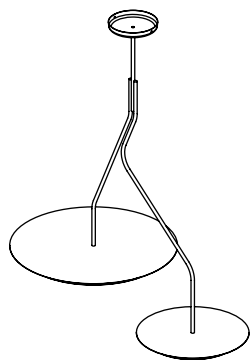

Light Disc . Lampada disco

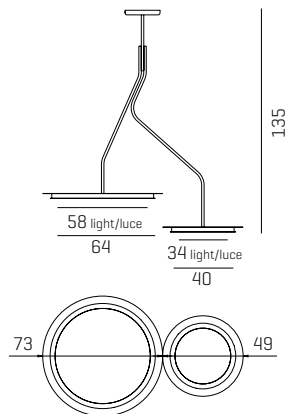

LIGHT.DISC05

8.909

120 x 90 x 150

25 Kg

Pendant LED lamp, [energy efficiency index A] dimmable, energy-saving, warm light, adjustable inclination, transformers incorporated into the ceiling rose.

Finish

Brass finish, hand-burnished using traditional techniques.

DIMENSIONS

Disc Ø 73 cm power 41W - 3800Lm - 3000K

Disc Ø 49 cm power 26W - 2412Lm - 3000K

Lampada sospensione a led, [classe energetica tipo A] dimmerabile, basso consumo con luce calda, Regolazione dell'inclinazione. trasformatori inseriti nel rosone.

Finitura

Ottone brunito a mano secondo le tecniche tradizionali.

DIMENSIONI

Disco Ø 73 cm potenza 41W - 3800Lm - 3000

Disco Ø 49 cm potenza 26W - 2412Lm - 3000K

Flat Lamp

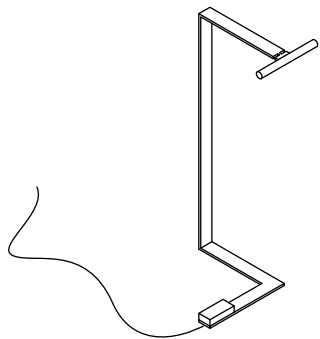

Flat Lamp

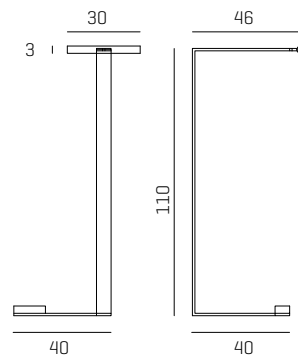

LIGHT.FLAT01

2.144

120 x 55 x 50

9 Kg

Standard floor lamp with brass pipe structure, size 60x10 mm
Multi-directional light, plaited power lead with red silk cover.

Finish

Finish hand-burnished using traditional techniques,
Energy-saving warm light LED bulb.

3W 276Lm 3.000K

DIMENSIONS

46 cm x 40 cm x 110 cm h

Lampada da terra con struttura in tubolare di ottone mis. 60x10 mm. Luce orientabile led, classe energetica tipo A++, basso consumo, regolazione dell'inclinazione, cavo di alimentazione a treccia con rivestimento in seta rossa.

Finitura

Brunita a mano secondo le tecniche tradizionali.

Lampadina Led a luce calda basso consumo.

3W 276Lm 3.000K

DIMENSIONI

46 cm x 40 cm x 110 cm h

HENGE®

GENERAL SALES TERMS

This pricelist cancels and replaces all previous ones. The prices are expressed in units of one euro (€), and are retail to the public excluding VAT.

ORDERS

The orders must be sent in writing accompanied by an explanatory drawing if needed. The order will only be valid once it has been approved and accepted by Henge S.r.l. with their tacit assent by the day following its receipt. Any variations or changes to the order must be forwarded within the day following the date the order is received. After which the original order will be considered valid to all effects. CHANGES Any reductions or made to measure production will only be carried out if they are provided by the pricelist and in accordance with these sales terms. The construction of any special elements must be approved by our technical office and an estimate prepared for them.

DELIVERIES

The delivery terms are indicative and are not binding, and any delays will not give rise to any penalty or right to cancel the order. The prices are ex works from the retailer's store and include the packaging in cardboard boxes or wood crates if very fragile components are involved. The transport costs to the customer's premises and installation are not included. No responsibility will be accepted for deliveries to other destinations other than the retailer's store.

CLAIMS

All claims relative to transport damage must be made immediately to the haulier when the goods are unloaded. Any claims for production defects must be forwarded in writing (with backup photos) within 8 days from the date the goods are received. Any claims for delayed delivery will not be subject to damage repayment. All returned goods must be authorised by us beforehand. In the case of replacement or repair, the goods must be returned to us perfectly packaged, using our courier and with the relative bill of lading. The transport costs for the returned goods are the responsibility of the client or the company, depending on the reason for the return. For any controversies, Treviso Court will be the place of jurisdiction.

TOLERANCES

Henge products are unique pieces and entirely handmade, and therefore there could be notable differences in the finishes.

COVERS

The leather, wood and stones of the Henge range are natural and living materials, and any scars, scratches, veins and stretch marks are typical of a natural material and not considered defects, rather virtues that highlight the beauty of real leather.

UPKEEP

To clean and maintain the covers, respect the instructions given on the maintenance card. Otherwise we will decline all responsibility for any damage caused by incorrect maintenance and cleaning.

PAYMENTS

The goods must be paid for in the agreed terms, even if there are any claims. Any delayed or failed payments will involve us writing off any discounts that may have been allowed and charging back all the bank costs and arrears interest at the current legal rate. Failure to pay just one invoice on the due date, will give us the right to suspend all shipment of any other goods and to cancel any other orders that are in progress. The delivered products will remain our property until full and final payment has been made. For any disputes, Treviso Court will be the place of jurisdiction.

CONDIZIONI GENERALI DI VENDITA

Il presente listino annulla e sostituisce i precedenti. I prezzi sono espressi in unità di euro (€), e sono da considerarsi al pubblico I.V.A. esclusa.

ORDINI

Tutti gli ordini devono essere trasmessi per iscritto e accompagnati, ove necessario, da disegno esplicativo. L'ordine assume validità solo ad avvenuta approvazione ed accettazione della Henge S.r.l., con tacito assenso entro il giorno successivo dal suo ricevimento. Eventuali variazioni e/o modifiche all'ordine, potranno essere effettuate entro e non oltre il giorno successivo al ricevimento dell'ordine stesso. Trascorso questo termine, l'ordine viene ritenuto valido a tutti gli effetti.

MODIFICHE

Eventuali riduzioni o realizzazioni di elementi su misura verranno effettuate solo se previste nel presente listino ed in base alle condizioni ivi riportate. Le realizzazioni di elementi speciali dovranno essere accettate e preventivate dal nostro ufficio tecnico.

CONSEGNE

I termini di consegna sono sempre indicativi, non costituiscono impegno ed, in caso di ritardi, non possono dar luogo a penalità o annullamenti di ordini. I prezzi si intendono per merce resa franco magazzino rivenditore ed includono l'imballo in scatole di cartone o casse di legno in caso di presenza di componenti di particolare fragilità. Sono esclusi i costi di trasporto a domicilio e posa in opera. Non si accetta alcune responsabilità per consegne aventi destinazione diversa dal magazzino del rivenditore.

RECLAMI

Eventuali reclami per danni derivanti dal trasporto devono essere fatti al trasportatore al momento dello scarico. Eventuali reclami per difetti di fabbricazione dovranno essere fatti per iscritto, con documentazione fotografica, entro, e non oltre, 8 giorni dal ricevimento della merce. Eventuali reclami per ritardo nella consegna non potrà dar luogo a nessun risarcimento danni. Eventuali resi della merce dovranno essere autorizzati da noi preventivamente. In caso di sostituzione o riparazione, la merce deve ritornare perfettamente imballata a mezzo nostro corriere e con relativo documento di trasporto. Le spese di trasporto della merce, sono a carico del Cliente o dell'Azienda, a seconda della causale del reso. Per ogni controversia giudiziaria è competente il Foro di Treviso.

TOLLERANZE

I prodotti Henge sono da considerarsi pezzi unici, essendo realizzati interamente a mano, per cui le finiture possono presentare sensibili variazioni tra loro.

RIVESTIMENTI

Le pelli che rivestono i prodotti Henge vanno considerate come materia naturale e viva; perciò le eventuali cicatrici, i graffi, le venature e le smagliature, ne rappresentano una naturale peculiarità e non sono dunque da considerarsi difetti, bensì pregi che esaltano la bellezza della vera pelle. Marmi e pietre che rivestono i prodotti Henge sono materiali naturali e vivi, perciò le eventuali differenze di venature e colori non sono considerati difetti ma pregi.

MANUTENZIONE

Per la pulizia e la manutenzione dei rivestimenti si pone l'obbligo di rispettare tassativamente le modalità riportate nei cartellini di manutenzione. Contrariamente si declina ogni responsabilità per eventuali danni causati da una errata manutenzione e pulizia.

PAGAMENTI

Il pagamento della merce dovrà avvenire nei termini pattuiti anche in caso di eventuali contestazioni. Eventuali ritardi o insolvenze determineranno lo storno dello sconto cassa ove concesso e l'addebito delle spese bancarie e degli interessi mortori al tasso legale corrente. Il mancato pagamento anche di una sola fattura alla scadenza darà facoltà alla fornitrice di sospendere ogni inoltro di merce e di annullare qualsiasi altra commissione in corso. I prodotti consegnati, rimarranno di proprietà della fornitrice fino al momento in cui verranno completamente pagati. Per qualsiasi contestazione, sarà competente il Foro di Treviso.

CONCEPT, ART DIRECTION
Massimo Castagna - AD Architettura

GRAPHIC DESIGN
Gusto IDS

PRINTING
Grafiche Antiga

March 2015

HENGE
Via della Spiga 7
20121 Milano (MI) - Italy
Tel. +39.0438 1710600 - Fax +39.0438 1710113
www.henge07.com . atelier@henge07.com
Open by appointment

7 | VIA
DELLA
SPIGA

Offices and Factory
Via G. Verdi, 45
31010 Farra di Soligo (TV) - Italy

